



control solutions

TERACOM



TCW122B-CM Remote I/O module

Revision 4.8 / December 2022

USER MANUAL

www.teracomsystems.com

1. Short description

TCW122B-CM is a remote IO module for monitoring and control. It has 2 digital and 2 analog inputs. The supported 1-Wire interface can handle up to 2 temperature or 2 humidity-temperature sensors.

The controller has 2 relays with normally open and normally closed contacts. Every relay can be activated either remotely (WEB, SNMP etc.) or locally - from the status of the monitored parameter (temperature, humidity, analog voltage and dry contact). Only one parameter can manage the relay at the same time, but for every parameter can be sent e-mail/SNMP trap for alert conditions.

TCW122B-CM is suitable for environmental monitoring and local control of heater/coolers, home and industrial and automation, data acquisition systems, general remote control, and monitoring.

2. Features

- Password protected, web-based configuration and control;
- 2 digital inputs with "dry contact" and "logic level" modes;
- 2 analog inputs with 0 to 60VDC range;
- 2 relays with NO and NC contacts;
- 1-Wire interface for up to 2 temperature (TST1XX) or humidity-temperature (TSH2xx) sensors;
- SNMP v.1 support;
- SNMP traps and/or e-mail sending for alert conditions;
- SMTP with authentication (SSL/TLS is not supported);
- HTTP and SNMP port changing;
- HTTP and XML API commands;
- Remote firmware update.

3. Specifications

- Physical characteristics
Dimensions: 109 x 82 x 32 mm
Weight: 110 g
- Environmental limits
Operating temperature range: -20 to 55°C
Storage temperature range: -25 to 60°C
Operating relative humidity range: 5 to 85% (non-condensing)
- Warranty
Warranty period: 3 years
- Power supply
Operating voltage range (including -15/+20% according to IEC 62368-1): 10 to 14 VDC
Current consumption (with both relays ON): 0.2 A @ 12 VDC
- Ethernet connectivity
10 Mbit/s transfer rate
Half-duplex mode only
Auto-negotiation not supported
- Digital inputs
Isolation: Non-isolated
Mode: Dry contact or Logic level

Maximum input voltage: +5.5VDC

Minimum input voltage for high logic level: +2.5VDC

Maximum input voltage for low logic level: +0.8VDC

Sampling rate: 10ms

Digital filtering time interval: 30ms

- Analog inputs

Isolation: Non-isolated

Type: Single-ended

Resolution: 10 bits

Mode: Voltage

Input Range: 0 to 60 VDC

Accuracy: $\pm 1\%$

Sampling Rate: 37.6ms per channel (averaged value of 64 samples)

Input Impedance: 1 mega-ohm (min.)

- Relay outputs

Type: Form C (N.O. and N.C. contacts)

Contact current rating: 3 A @ 24 VDC/30 VAC (resistive load)

Initial insulation resistance: 100 mega-ohms (min.) @ 500 VDC

Mechanical endurance: 10 000 000 operations

Electrical endurance: 100 000 operations @ 3 A resistive load

Contact resistance: 50 milli-ohm max. (initial value)

Minimum pulse output: 1 Hz at rated load

CAUTION: The device does not contain any internal overcurrent protection facilities on the relays' contact lines.

External fuses or short circuit current limiting circuit breakers, rated to 3 Amps, are to be used for overcurrent protection of the connecting lines.

- 1-Wire interface

Output voltage (+VW): 5.3 ± 0.2 VDC

Maximum output current (+VW): 0.2 A

- Internal FLASH memory

Endurance: 100 000 cycles (Every relay status and settings change is a memory cycle.)

4. Powering

TCW122B-CM is designed to be supplied by adapter SYS1421-0612-W2E or similar, intended for use in the conditions of overvoltage category II, and priorly assessed for compliance with safety requirements. The power supply equipment shall be resistant to short circuit and overload in the secondary circuit.

When in use do not position the equipment so that it is difficult to disconnect the device from the power supply.

5. LED indicators

The following indicators show the status of the controller:

- Relay1/Relay2 (green) – these LEDs are illuminated whenever the corresponding relay is activated (the NO contact is closed and the NC contact is open);
- Sts (red) – flashes when the main program of the controller is executed;
- Log (yellow) – indicates that somebody is logged via the WEB interface;
- Net (green/red) – red when the device is linked, yellow when there is an activity.

6. Connectors

Inputs and outputs locations are shown below:

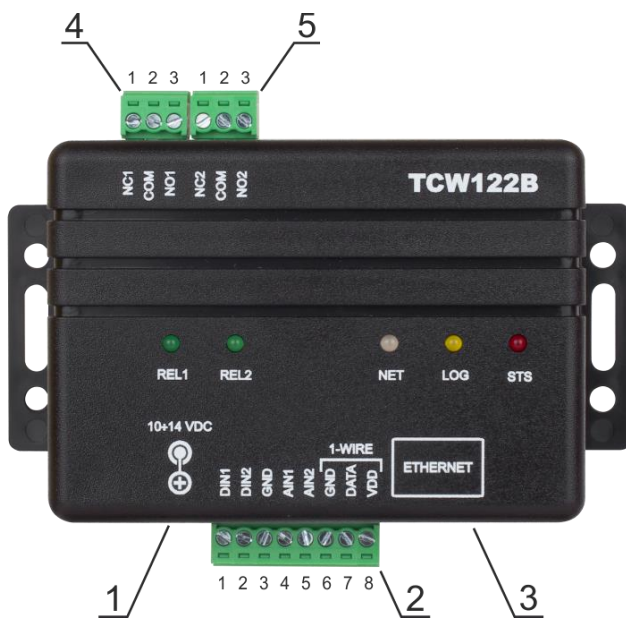

Connector 1 – Power - 2.1x5.5mm connector, central positive

Connector 2, Pin1 – Digital input 1 (**Din1**)*

Connector 2, Pin2 – Digital input 2 (**Din2**)*

Connector 2, Pin3 – Ground

Connector 2, Pin4 – Analog input 1 (**Ain1**)

Connector 2, Pin5 – Analog input 2 (**Ain2**)

Connector 2, Pin6 – Ground

Connector 2, Pin7 – 1-Wire data

Connector 2, Pin8 – 1-Wire power supply

Connector 3 – Ethernet - RJ45

Connector 4, Pin1 – NC Relay1

Connector 4, Pin2 – COM Relay1

Connector 4, Pin3 – NO Relay1

Connector 5, Pin1 – NC Relay2

Connector 5, Pin2 – COM Relay2

Connector 5, Pin3 – NO Relay2

* Operating mode is selected by jumper DI1/DI2 - closed for “dry contact” and open for “logic level”. By default, jumpers are closed.

7. Installation

This device must be installed by qualified personnel.

This device must not be installed directly outdoors.

The installation consists of mounting the device, connecting to an IP network, connecting inputs and outputs, providing power and configuring via a web browser.

TCW122B-CM can be wall or flat, not flammable surface mounted, in a clean and dry location room. Ventilation is recommended for installations where the ambient air temperature is expected to be high.

Mount the device to a wall by using two plastic dowels 8x60mm (example Würth GmbH 0912 802 002) and two dowel screws 6x70mm (example Würth GmbH 0157 06 70). Attach the screws to the surface vertically. See Appendix-A, fig. 1 for mechanical details.

Maintain spacing from adjacent equipment. Allow 50 mm of space on all sides, as shown in fig.2 in Appendix A, this provides ventilation and electrical isolation.

8. Configuration

Please follow the steps below for proper installation:

1. Mount the controller in a dry and ventilated place.
2. Connect the Ethernet port to a 10/100MB Ethernet network. For direct connection to a PC using a “crossover” cable.
3. Connect the I/O pins of the controller according to the required application.
4. Connect the power supply.

If the red LED (STS) blinks, the main program of the controller is executed. By default TCW122B-CM comes with the following network settings:

IP address: 192.168.1.2, Subnet Mask: 255.255.255.0, Default Gateway: 192.168.1.1

Communication with TCW122B-CM can be established by assigning a temporary IP address to the computer. This address should be on the same network (for example 192.168.1.3). To get access to the web interface, you should type http://192.168.1.2 into the browser.

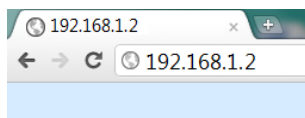

If the network settings are correct, the “Login” page will appear.

The web-based interface allows configuration, monitoring, and control.

8.1. Login page

After opening the Login page, authorization data must be entered (by default username=admin, password=admin). It is recommended to change the username and password to prevent unauthorized access to the controller.



The controller supports one active session – only one user can operate the device over the WEB interface. If another user tries to log in, the message “Someone is logged in” appears:

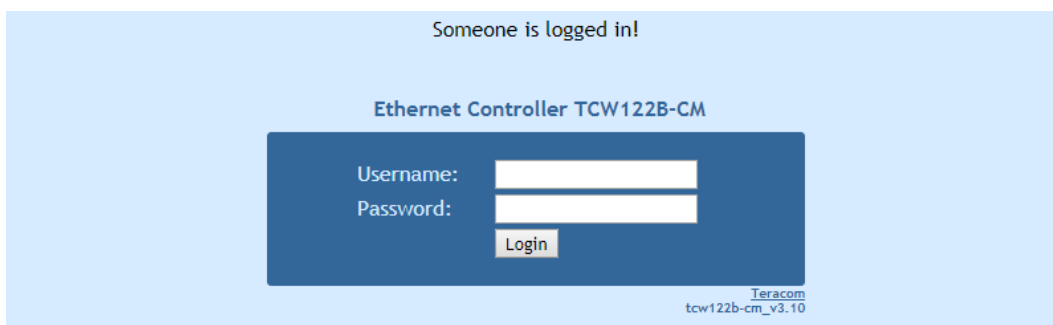

The active session will stay open until the "Monitoring" page is open. Inactivity on other pages or closing the browser without logoff will terminate the session automatically in 4 minutes.

8.2. Monitoring page

After successful authorization, the “Monitoring” page appears:

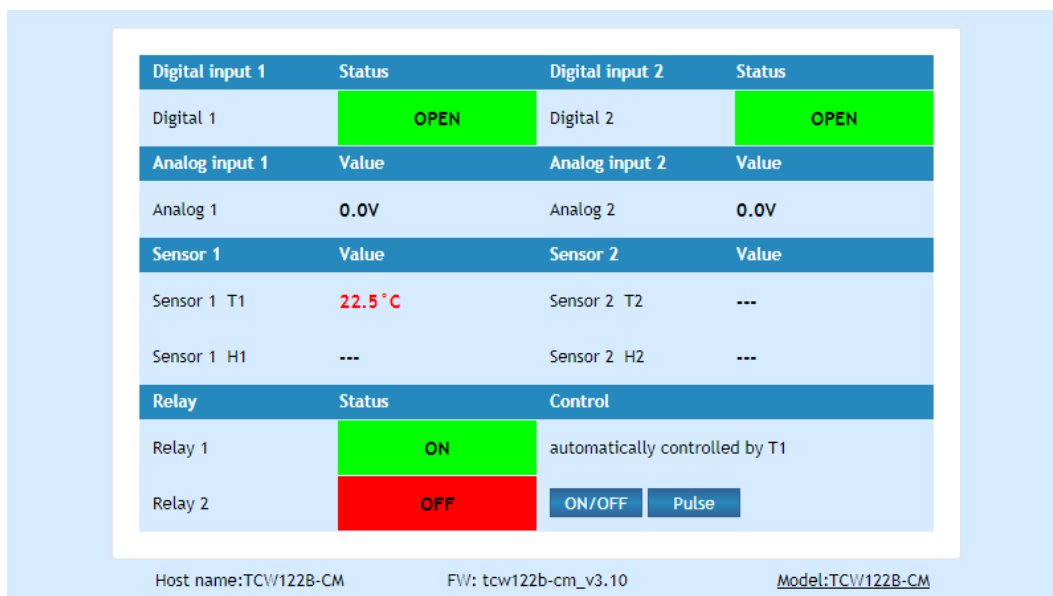

The “Monitoring” page provides information about the state of the relays and digital inputs, values of analog voltages (applied on analog inputs), temperature and humidity.

The state of the relay can be changed by appropriate “ON/OFF” button. To change the state of the relay for a specified time, the “Pulse” button should be pressed. Duration of the pulse is specified in “Pulse Duration” field of “I/O Setup” page.

Digital inputs can be used for monitoring the state of discrete devices – motion sensor, door contact, relay contact, alarm output etc. All digital inputs are not galvanic isolated. One side of the contact is connected to “Digital In” and another side is connected to “GND” pins.

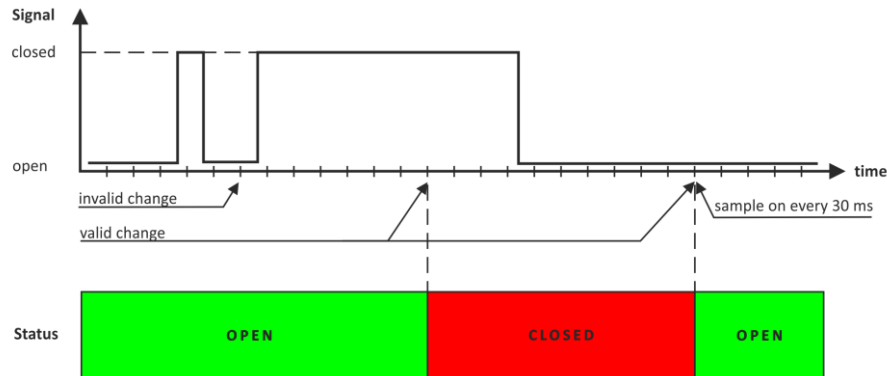

Digital inputs are sampled every 30ms. The change of input status is considered valid if the same value is read in seven consecutive samples.

8.3. Network Setup page

The Network parameters are set on this page. The following parameters can be changed:

- IP configuration – IP Address can be static or dynamic (DHCP server should be present in the network);
- IP address, Subnet mask, Default gateway – these fields are active if the IP address is static;
- DNS – this field is mandatory if domain names are used instead of IP addresses. By default DNS has the same IP address as Default gateway;
- Time Server and Time Zone – these fields are not mandatory, they are used when e-mail must be sent;
- Host Name – up to 16 symbols, it appears as a “Subject” in sent e-mails;
- MAC – device MAC address.

The screenshot shows the Network Setup page with the following fields:

IP configuration	
Static/DHCP	Static
IP address	192.168.1.2
Subnet mask	255.255.255.0
Default gateway	192.168.1.1
DNS	8.8.8.8
Time server	time.google.com
Time zone	+0000
Host Name	TCW122B-CM
MAC Address	
MAC	00:04:A3:AA:00:05

The good practice is to change the default IP address of the controller immediately after first power-on. This will avoid collisions if many devices are used in the same network. It may be

necessary to clear the arp cache, each time you connect a new device to the network. This is done by typing arp -d in the command prompt window of the computer.

To use e-mail alerts following fields should be completed:

- Mail server type – either “custom” or “tcwgateway”.
“Custom” – public or private mail server without SSL should be used.
Important! TCW122B-CM does not support Secure Socket Layer (SSL);
“Tcwgateway” - dedicated mail server is used.
Important! The service is free and not guaranteed.
- Mail server [IP:port] – domain or IP address and port of SMTP mail server;
- Sender E-mail – sender e-mail;
- Username and Password – authentication details for mail server;
- Recipient e-mail.

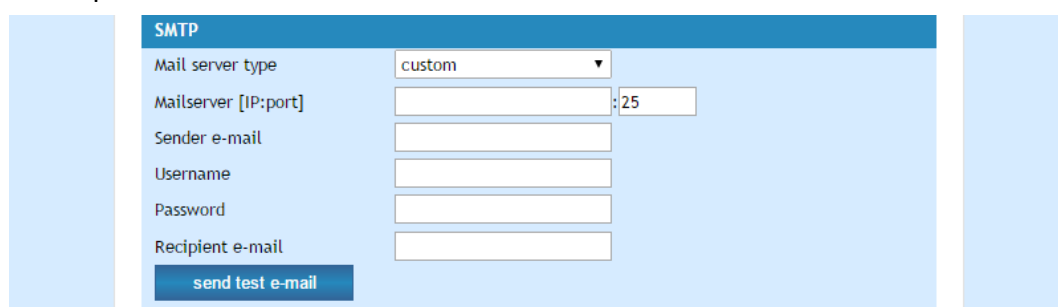

Username and password for WEB access to TCW122B-CM can be changed in the Web Access section. Setting the authentication to “disabled” will provide access to monitoring page without entering username and password. The HTTP port can be changed also in this section.

XML/HTTP API section controls the access to XML file and HTTP commands. Detailed information can be found in the chapter “XML and HTTP API commands”.

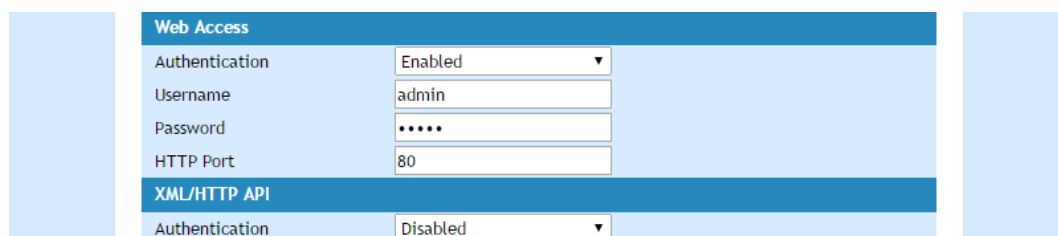

8.4. SNMP Setup page

TCW122B-CM supports SNMP v.1. This enables the device to be part of large monitoring and control networks. The possible settings for “SNMP” section are:

- SNMP Configuration – enable/disable SNMP;
- SNMP Port – allows standard port changing;
- Write/Read community – performs client authentication;
- SNMP Traps – enable/disable SNMP trap messages;
- IP address – IP address of the receiving host;
- Community string – performs client authentication;
- Trap Interval - time interval in seconds for SNMP trap messages;
- Max. Traps number – the maximum number of SNMP trap messages sent if trap condition is present.

SNMP traps are sent if:

- event occurs (status change) on Digital Input 1 or Digital Input 2;
- measured voltage on Analog Input 1 or Analog Input 2 goes outside the range;
- measured temperature goes outside the range;
- measured humidity goes outside the range;
- restart condition.

8.5. I/O setup page

I/O settings can be made here. For temperature, humidity and analog value MIN, MAX, and HYSTERESIS values can be set. These values define the thresholds for all monitored parameters.

When the measured value goes out of range SNMP trap or e-mail (if enabled) will be sent. Leaving range is considered when the parameter goes lower than MIN values or higher than MAX. Coming back in the range is considered when the parameter goes higher than (MIN + HYSTERESIS) or lower than (MAX – HYSTERESIS).

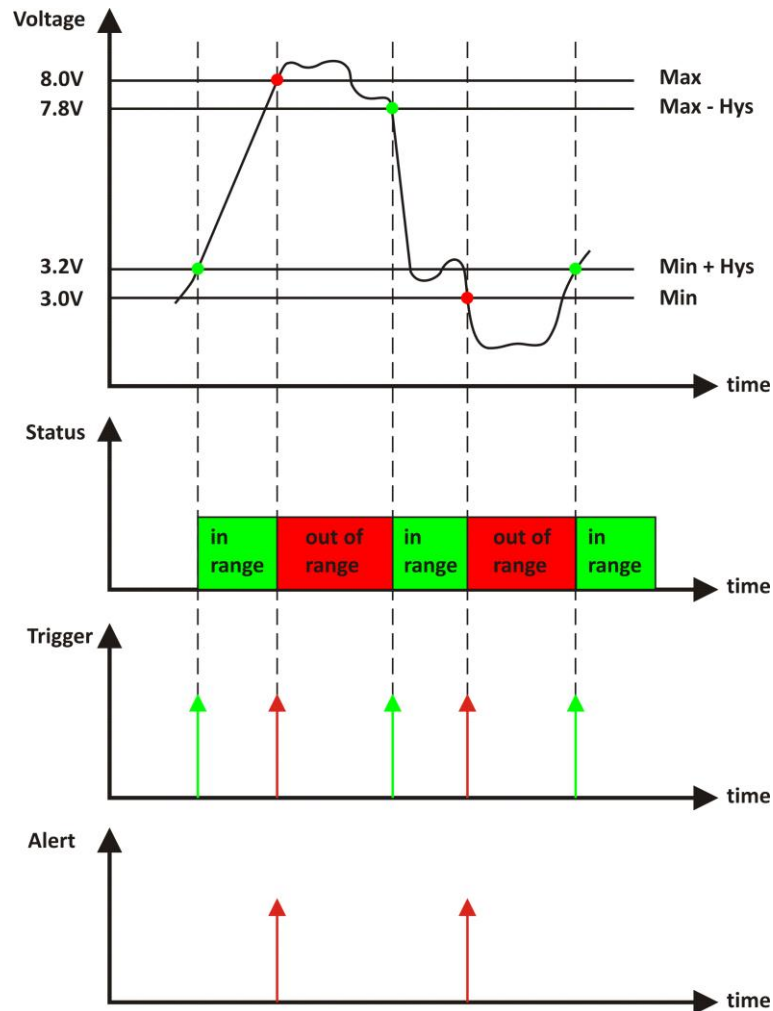

Example:

TCW122B-CM, TST100, and appropriate heater are used to control the room temperature. The wanted minimum temperature is 19°C. The initial temperature is 17°C.

TST100 is assigned to the first position for 1-Wire sensors.

For Relay1 local activation from Sensor1 is set.

Sensor 1				
	Min.	Max.	Hysteresis	If out of range
Temperature, °C	19	100	0.5	send_email ▼
Humidity, %RH	0.0	80.0	1.0	do nothing ▼

Following parameters are set for Sensor1: Min=19, Max=100 and Hys=0.5.

When the controller is switched on, Relay1 is immediately activated because the monitored temperature is out of range. This switches the heater on. The temperature is going higher.

When temperature reaches 19.5°C (19.0 + 0.5) it goes in range (trigger condition) and Relay1 is deactivated. The heater is switched off.

The temperature falls and when it reached 19°C it goes out of range (trigger and alert conditions). The relay is activated (heater is switched on) and e-mail is sent.

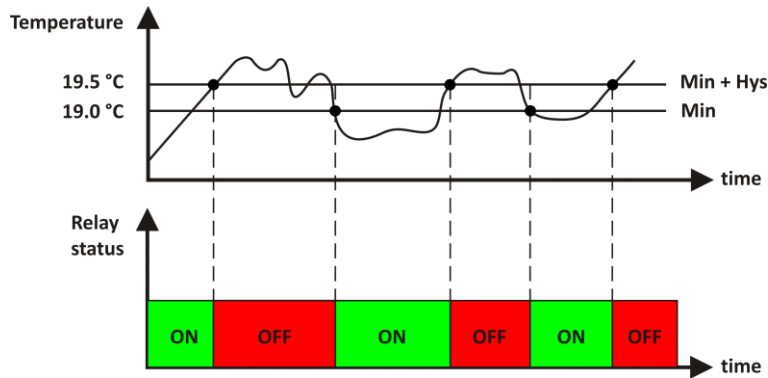

For digital inputs, conditional email sending can be arranged by following part of the page:

Digital inputs	
Input 1 Alert	disable
Input 2 Alert	disable

Relays can be activated automatically depends on the value of the monitored parameter (humidity, temperature, analog voltage and changes on digital inputs) or manually. Only one parameter can be assigned for relay activation, at the same time:

Relays	
Pulse Duration	1 sec(1-253)
Relay1 Activated from	T1
Relay2 Activated from	manual
Save relay state after change via HTTP API	No
change via WEB	Yes

100 000 write cycles are guaranteed

When manual activation is selected, “Pulse” and “ON/OFF” buttons on “Monitoring” page are active. The duration of the pulse for relay activation can be set from 1 to 253 seconds.

By default, relay state changes via the WEB interface are memorized in non-volatile memory. After the power on, the relay goes in its last state, before the power down.

If the “Save relay state after change via WEB” is No, after power on the relay is always OFF.

By default, relay state changes via the HTTP API aren’t saved and after power on the relay is always OFF.

The guaranteed write cycles (every change saving doesn’t matter via HTTP API or WEB) are 100000.

For every sensor, analog input, digital input and relay description with a length of 11 characters can be set.

Descriptions	
Sensor 1	Sensor 1
Sensor 2	Sensor 2
Analog Input 1	Analog 1
Analog Input 2	Analog 2
Digital Input 1	Digital 1
Digital Input 2	Digital 2
Relay 1	Relay 1
Relay 2	Relay 2

Temperature units can be changed between Fahrenheit and Celsius.

Units	
Temperature Units	C

Automatic monitoring page refresh interval can be set from 1 to 253 second.

Monitoring page	
Refresh Interval	1 sec(1-253)

8.6. Update page

For details see chapter 13. Firmware update.

9. Application examples

The examples and diagrams in this manual are included solely for illustrative purposes. Because of the many variables and requirements associated with any particular installation, Teracom Ltd. cannot assume responsibility or liability for actual use based on the examples and diagrams.

9.1. Temperature and humidity control

TCW122B-CM supports 1-Wire temperature and humidity sensors, which makes it suitable for use in heating and cooling systems.

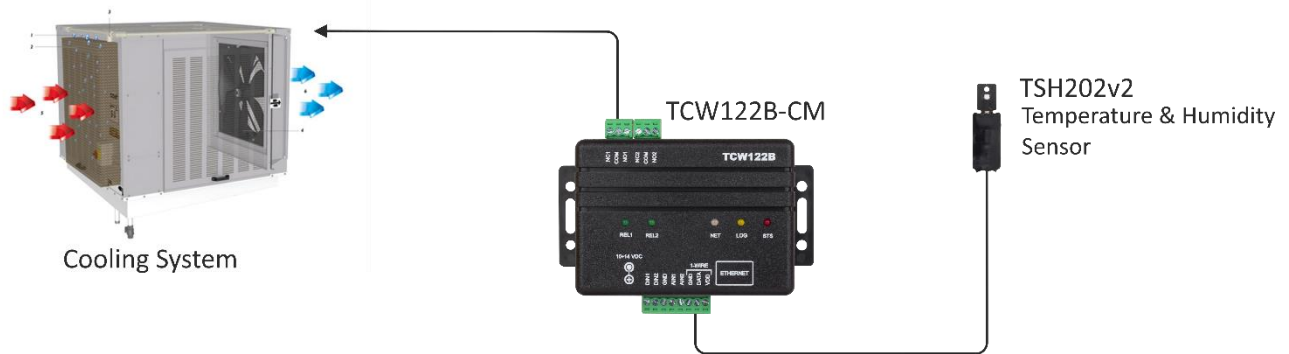

9.2. Remote control

The controlled device is connected in series with the relay contacts. Users can operate TCW122B-CM using a web browser or SNMP application. Both relays are managed independently.

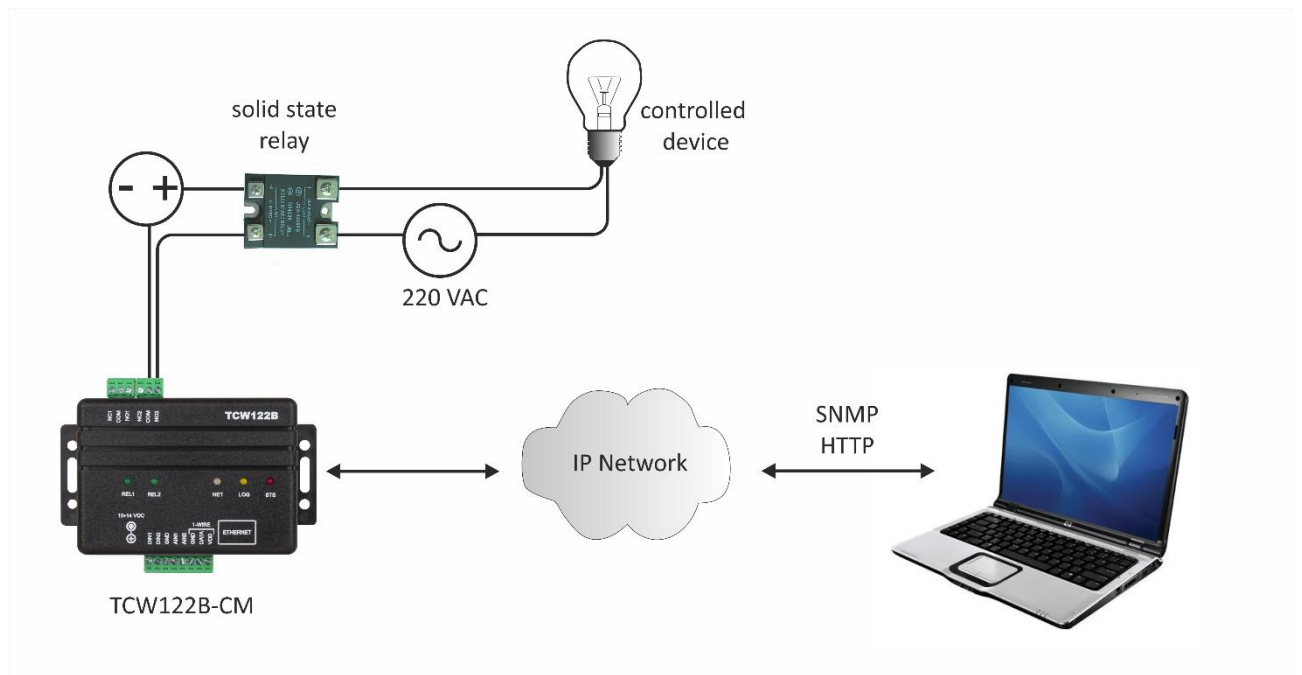

9.3. Remote monitoring

A relay contact of the monitored device is connected to the digital input. When an event occurs – the controller can send an e-mail and/or SNMP trap.

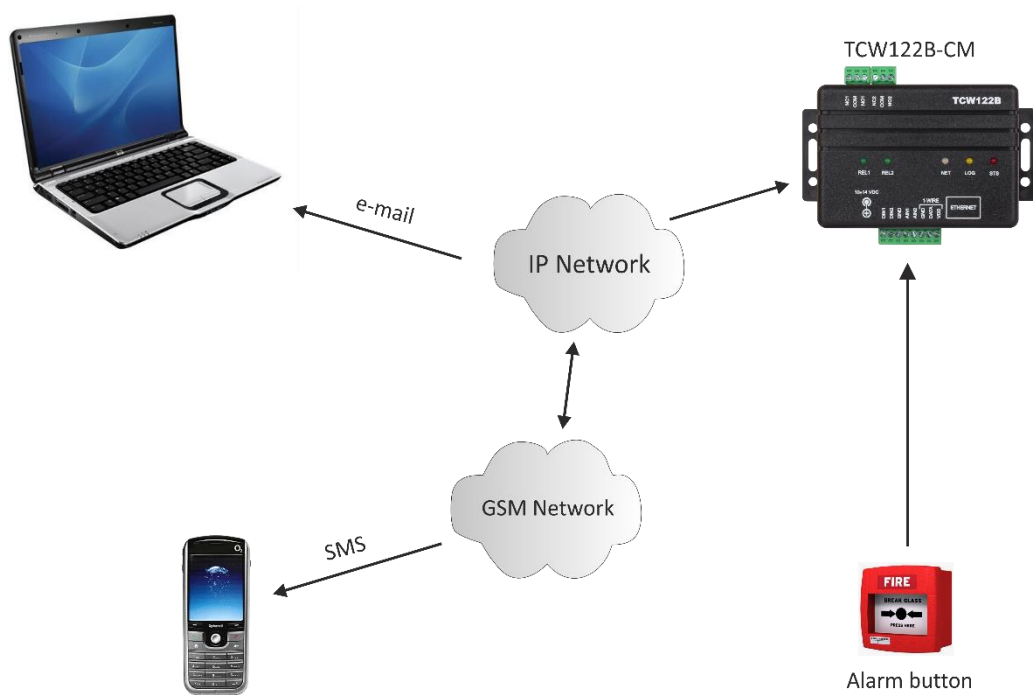

9.4. Data acquisition

The TCW122B-CM can be used in Data Acquisition Systems (DAQ). The device uses SNMP v.1 protocol for communication with monitoring and management software applications.

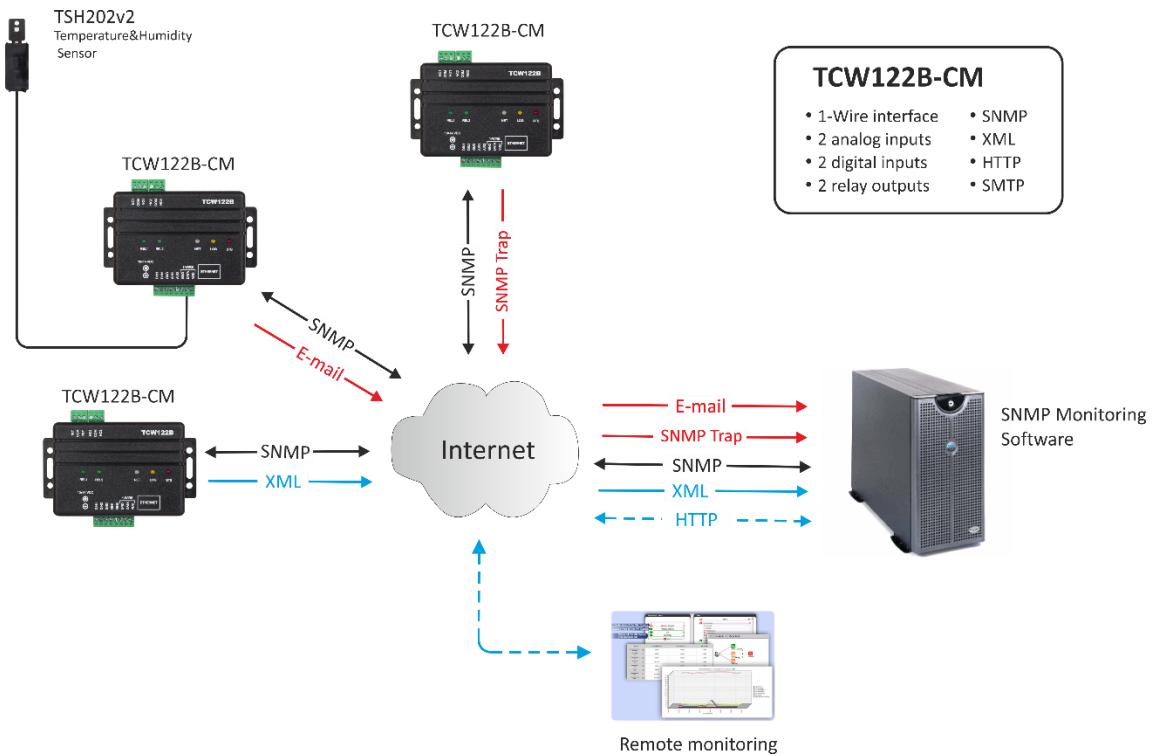

10. 1-Wire Bus

1-Wire is a registered trademark of Maxim Integrated Products, Inc. It is designed to connect several sensors over a short wiring. The bus carries power and a single data wire. It is not suitable for long distances or environments with EMC interference.

We strongly recommend reading Maxim's 1-Wire tips at <https://www.teracomsystems.com/wp-content/uploads/1-wire/guidelines-for-reliable-long-line-1-wire-networks.pdf>.

The total wiring length should be up to 30m, although functionality has been achieved in the longer distance. We cannot guarantee error-free operation over mentioned wiring length.

We guarantee proper operation only with our 1-Wire sensors series TST1XX and TSH2XX.

11. Control and monitoring using SNMP

TCW122B-CM can be configured and monitored through SNMP (Simple Network Management Protocol). This could be done using every SNMP v.1 compatible program. Parameters that can be changed, are grouped according to their functions in the tables below. To obtain a valid OID number it is necessary to replace the "x" symbol with "1.3.6.1.4.1.38783". To save the changes *configurationSaved* (OID x.3.13.0) should be set to "1".

11.1. Product

OID	Name	Access	Description	Syntax
x.1.1.0	name	read-only	Device name	String
x.1.2.0	version	read-only	Firmware version	String
x.1.3.0	date	read-only	Release date	String

11.2. Setup -> network

OID	Name	Access	Description	Syntax
x.2.1.1.0	deviceIPAddress	read-write	Device IP address	IpAddress
x.2.1.2.0	subnetMask	read-write	Subnet Mask	IpAddress
x.2.1.3.0	gateway	read-write	Gateway	IpAddress
x.2.1.4.0	deviceMACAddress	read-write	Device MAC Address	OCTET STRING (SIZE(6))
x.2.1.5.0	dhcpConfig	read-write	DHCP configuration ON/OFF	INTEGER { off(0), on(1) }
x.2.1.6.0	dns	read-write	Domain Name Server address	IpAddress
x.2.1.7.0	Hostname	read-write	Device hostname	String (SIZE (0..38))

11.3. Setup -> snmpSetup

OID	Name	Access	Description	Syntax
x.2.4.1.0	snmpConfiguration	read-write	SNMP Configuration	INTEGER { disabled(0), enabled(1) }
x.2.4.2.0	trapEnabled	read-write	TRAP messages ENABLED/DISABLED	INTEGER { no(0), yes(1) }
x.2.4.3.0	trapReceiverIPAddress	read-write	TRAP receiver IP address	IpAddress
x.2.4.4.0	trapCommunity	read-write	TRAP community	String (SIZE (0..13))
x.2.4.5.0	trapInterval	read-write	TRAP messages interval	INTEGER (1..253)
x.2.4.6.0	maxNumberOfTraps	read-write	Maximum number SNMP traps	INTEGER (1..253)

11.4. Setup -> oneWireSensor1 -> temperature1

OID	Name	Access	Description	Syntax
x.2.5.1.1.0	temperature1Min	read-write	Temperature1 range (min. value)	INTEGER (-400..1250)
x.2.5.1.2.0	temperature1Max	read-write	Temperature1 range (max. value)	INTEGER (-400..1250)
x.2.5.1.3.0	temperature1Hyst	read-write	Hysteresis	INTEGER (0..1250)
x.2.5.1.4.0	temperature1Action	read-write	Temperature1 action	INTEGER { noAction(0), sendMail(1) }

11.5. Setup -> oneWireSensor1 -> humidity1

OID	Name	Access	Description	Syntax
x.2.5.2.1.0	humidity1Min	read-write	Humidity1 range (min. value)	INTEGER (0..1000)
x.2.5.2.2.0	humidity1Max	read-write	Humidity1 range (max. value)	INTEGER (0..1000)
x.2.5.2.3.0	humidity1Hyst	read-write	Hysteresis	INTEGER (0..1000)
x.2.5.2.4.0	humidity1Action	read-write	Temperature1 action	INTEGER { noAction(0), sendMail(1) }

11.6. Setup -> oneWireSensor2 -> temperature2

OID	Name	Access	Description	Syntax
x.2.6.1.1.0	temperature2Min	read-write	Temperature2 range (min. value)	INTEGER (-400..1250)
x.2.6.1.2.0	temperature2Max	read-write	Temperature2 range (max. value)	INTEGER (-400..1250)
x.2.6.1.3.0	temperature2Hyst	read-write	Hysteresis	INTEGER (0..1250)
x.2.6.1.4.0	temperature2Action	read-write	Temperature2 action	INTEGER { noAction(0), sendMail(1) }

11.7. Setup -> oneWireSensor2 -> humidity2

OID	Name	Access	Description	Syntax
x.2.6.2.1.0	humidity2Min	read-write	Humidity2 range (min. value)	INTEGER (0..1000)
x.2.6.2.2.0	humidity2Max	read-write	Humidity2 range (max. value)	INTEGER (0..1000)
x.2.6.2.3.0	humidity2Hyst	read-write	Hysteresis	INTEGER (0..1000)
x.2.6.2.4.0	humidity2Action	read-write	Temperature2 action	INTEGER { noAction(0), sendMail(1) }

11.8. Setup -> analogInput -> input1

OID	Name	Access	Description	Syntax
x.2.7.1.1.0	voltage1Min	read-write	Voltage1 alarm range (min. value)	INTEGER (0..1000)
x.2.7.1.2.0	voltage1Max	read-write	Voltage1 alarm range (max. value)	INTEGER (0..1000)
x.2.7.1.3.0	voltage1Hyst	read-write	Voltage1 hysteresis	INTEGER (0..1000)
x.2.7.1.4.0	voltage1Action	read-write	Voltage1 action	INTEGER { noAction(0), sendMail(1) }
x.2.7.1.5.0	voltage1Description	read-write	Voltage 1 description	DisplayString (SIZE (0..11))

11.9. Setup -> analogInput -> input2

OID	Name	Access	Description	Syntax
x.2.7.2.1.0	voltage2Min	read-write	Voltage2 alarm range (min. value)	INTEGER (0..1000)
x.2.7.2.2.0	voltage2Max	read-write	Voltage2 alarm range (max. value)	INTEGER (0..1000)
x.2.7.2.3.0	voltage2Hyst	read-write	Voltage2 hysteresis	INTEGER (0..1000)
x.2.7.2.4.0	voltage2Action	read-write	Voltage2 action	INTEGER { noAction(0), sendMail(1) }
x.2.7.2.5.0	voltage2Description	read-write	Voltage 2 description	DisplayString (SIZE (0..11))

11.10. Setup -> digitalinput

OID	Name	Access	Description	Syntax
x.2.8.1.0	digitalinput1Action	read-write	Digital Input1 action	INTEGER { noAction(0), mailIfOpenToClosed(1), mailIfClosedToOpen(2) }
x.2.8.2.0	digitalinput2Action	read-write	Digital Input2 action	INTEGER { noAction(0), mailIfOpenToClosed(1), mailIfClosedToOpen(2) }
x.2.8.3.0	digitalInput1Description	read-write	Digital Input 1 description	DisplayString (SIZE (0..11))
x.2.8.4.0	digitalInput2Description	read-write	Digital Input 2 description	DisplayString (SIZE (0..11))

11.11. Setup -> relay

OID	Name	Access	Description	Syntax
x.2.9.1.0	relay1ControlledBy	read-write	Relay1 control item	INTEGER { manual(0), temperature1(1), humidity1(2), analogInput1(3), digitalInput1(4), temperature2(5), humidity(6), analogInput2(7), digitalInput2(8) }
x.2.9.2.0	relay2ControlledBy	read-write	Relay2 control item	INTEGER { manual(0), temperature1(1), humidity1(2), analogInput1(3), digitalInput1(4), temperature2(5), humidity(6), analogInput2(7), digitalInput2(8) }
x.2.9.3.0	relayPulseWidth	read-write	Digital Inputs mail recipient	INTEGER{ 1..253 }
x.2.9.4.0	relay1Description	read-write	Relay 1 description	DisplayString (SIZE (0..11))
x.2.9.4.0	relay2Description	read-write	Relay 2 description	DisplayString (SIZE (0..11))

11.12. Setup -> recipients

OID	Name	Access	Description	Syntax
x.2.10.1.0	recipient1EmailAddress	read-write	Recipient1 e-mail	String (SIZE (0..38))

11.13. Monitor&control

OID	Name	Access	Description	Syntax
x.3.1.0	digitalInput1State	read-only	Digital Input1 state	INTEGER { closed(0), open(1) }
x.3.2.0	digitalInput2State	read-only	Digital Input2 state	INTEGER { closed(0), open(1) }
x.3.3.0	relay1State	read-write	Relay1 state	INTEGER { off(0), on(1) }
x.3.4.0	relay1Pulse	read-write	Relay1 pulse	INTEGER { off(0), on(1) }
x.3.5.0	relay2State	read-write	Relay2 state	INTEGER { off(0), on(1) }
x.3.6.0	relay2Pulse	read-write	Relay2 pulse	INTEGER { off(0), on(1) }
x.3.7.0	voltage1x10Int	read-only	Voltage1 x10 in integer format	INTEGER{ 0..1000 }
x.3.8.0	voltage2x10Int	read-only	Voltage2 x10 in integer format	INTEGER{ 0..1000 }
x.3.9.0	temp1x10Int	read-only	Temperature1 x10 in integer format	INTEGER{ -400..1250 }
x.3.10.0	temp2x10Int	read-only	Temperature2 x10 in integer format	INTEGER{ -400..1250 }
x.3.11.0	humi1x10Int	read-only	Humidity1 x10 in integer format	INTEGER{ 0..1000 }
x.3.12.0	humi2x10Int	read-only	Humidity2 x10 in integer format	INTEGER{ 0..1000 }
x.3.13.0	configurationSaved	read-write	Configuration save status	INTEGER { unsaved(0), saved(1) }
x.3.14.0	restartDevice	read-write	Restart device	INTEGER { cancel(0), restart(1) }
x.3.15.0	temperatureUnits	read-write	Temperature Units	INTEGER { celsius(0), fahrenheit(1) }

12. XML and HTTP API commands

XML is often preferred choice when it comes to M2M communication and system integration. The monitored values are transmitted in status.xml file that can be easily processed by software applications.

The structure of the status.xml file is:

```
<Monitor>
  <Device>TCW122B-CM</Device>
  <ID>5C:32:C5:AA:00:05</ID>
  <Hostname>TCW122B-CM</Hostname>
  <FW>3.10</FW>
  <DigitalInput1Description>Digital 1</DigitalInput1Description>
  <DigitalInput1>CLOSED</DigitalInput1>
  <DinAlarm1>0</DinAlarm1>
  <DigitalInput2Description>Digital 2</DigitalInput2Description>
```

```

<DigitalInput2>CLOSED</DigitalInput2>
<DinAlarm2>0</DinAlarm2>
<AnalogInput1Description>Analog 1</AnalogInput1Description>
<AnalogInput1>12.2V</AnalogInput1>
<AinAlarm1>0</AinAlarm1>
<AnalogInput2Description>Analog 2</AnalogInput2Description>
<AnalogInput2>23.8V</AnalogInput2>
<AinAlarm2>0</AinAlarm2>
<Sensor1Description>Sensor 1</Sensor1Description>
<Temperature1>22.4°C</Temperature1>
<TempAlarm1>0</TempAlarm1>
<Humidity1>41.8%RH</Humidity1>
<HumAlarm1>0</HumAlarm1>
<Sensor2Description>Sensor 2</Sensor2Description>
<Temperature2>---</Temperature2>
<TempAlarm2>0</TempAlarm2>
<Humidity2>---</Humidity2>
<HumAlarm2>0</HumAlarm2>
<Relay1Description>Relay 1</Relay1Description>
<Relay1>OFF</Relay1>
<Relay1Control/>
<Relay2Description>Relay 2</Relay2Description>
<Relay2>OFF</Relay2>
<Relay2Control/>
<pulseWidth>5</pulseWidth>
</Monitor>

```

If XML/HTTP API authentication is enabled, basic access authentication is required to access the status.xml file. The format of the command is shown in the table below:

XML/HTTP API authentication	Format
enabled	http://device.ip.address/status.xml?a= uuuu:pppp
disabled	http://device.ip.address/status.xml

Where **uuuu** is username and **pppp** is password. Both parameters are unencrypted.

The following HTTP commands are supported:

Command	Description
http://device.ip.address/status.xml?r1=1	Turn Relay 1 ON
http://device.ip.address/status.xml?r1=0	Turn Relay 1 OFF
http://device.ip.address/status.xml?r2=1	Turn Relay 2 ON
http://device.ip.address/status.xml?r2=0	Turn Relay 2 OFF
http://device.ip.address/status.xml?tg1=1	Toggle Relay 1 state
http://device.ip.address/status.xml?pl1=1	Pulse Relay 1
http://device.ip.address/status.xml?r1=1&r2=1	Turn both relays ON
http://device.ip.address/status.xml?r1=0&r2=0	Turn both relays OFF

If XML/HTTP API authentication is enabled, basic access authentication is required to send HTTP commands. The format of the commands is shown in the table below (user name=admin, pass=admin):

XML/HTTP API authentication	Format
enabled	http://device.ip.address/status.xml?a= admin:admin&r1=1
disabled	http://device.ip.address/status.xml?r1=1

13. Firmware update

TCW122B-CM supports remote firmware update. To update the device follow the steps below:

- Go to www.teracomsystems.com and download the latest firmware version from TCW122B-CM product page;
- Go to the login page, enter a username, and password and press the “Login” button;
- Go to the “Update” menu, select the update .cod file and press “upload” button;

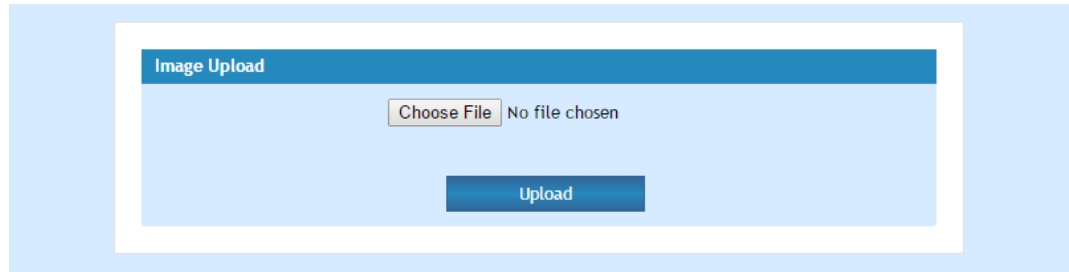

- After the firmware update is completed, you will be forwarded to the device Login page.

Attention! Don't turn off the power supply during the update. Turning off the power supply will damage the device.

For some updates factory default settings procedure is mandatory.

14. Factory default settings

TCW122B-CM can be restored to its original factory default settings, following the steps below:

- Turn off the power supply;
- Press and hold the RESET button then turn on the power supply;
- After turning the power supply release the RESET button. The LED's STS and LOG will flash 14 times after that only the STS LED will continue to blink. The controller is restored to its default settings.



The factory default settings are:

User Name (Admin)	admin
Password (Admin)	admin
IP Address	192.168.1.2
Subnet Mask	255.255.255.0
Default Gateway	192.168.1.1
SNMPConfiguration	disabled
readCommunity	public
writeCommunity	private

15. Environment information

This equipment is intended for use in a Pollution Degree 2 environment, at altitudes up to 2000 meters. When the controller is a part of a system, the other elements of the system shall comply with the EMC requirements and shall be intended for use in the same ambient conditions.

16. Safety

This device must not be used for medical, life-saving purposes or for any purpose where its failure could cause serious injury or the loss of life.

To reduce the risk of fire, only flexible stranded wire, with cross-section 0.5mm² or larger for wiring of digital and analog inputs and relay output of the device should be used.

To avoid electric shock and fire hazard, do not expose this product to liquids, rain, or moisture. Objects filled with liquids, such as vases, should not be placed on this device.

There is a risk of overheating (damage) of the controller if recommended free spaces to adjacent devices are not ensured. A joint part with external component shall have space for attachment/removal of the cable after installation.

Teracom does not guarantee a successful operation of the product if the product was used under conditions deviating from the product specifications.

To ensure that the device works correctly follow the steps below:

- ensure that the device is installed correctly, refer this user manual;
- log into the devices via a browser;
- make proper setup;
- set up the digital inputs to work in “dry contact” mode;
- short the “Din1” and “GND”;
- install sensor TSH1XX or TST1XX on the 1-Wire bus;
- go to “Monitoring page” of WEB interface – proper parameters value should be displayed at the same time flashing “STS” led should indicate the proper operation.

If the equipment is used in a manner not specified by the manufacturer, the protection provided by the equipment may be impaired.

In no event will Teracom Ltd. be responsible or liable for indirect or consequential damages resulting from the use or application of this equipment.

17. Maintenance

Upon completion of any service or repairs to the device or once per year, a safety check must be performed to determine that this product is in proper operating condition. Clean the device only with a dry cloth. Do not use a liquid cleaner or an aerosol cleaner. Do not use a magnetic/static cleaning device (dust remover) or any kind of abrasive materials to clean the device.

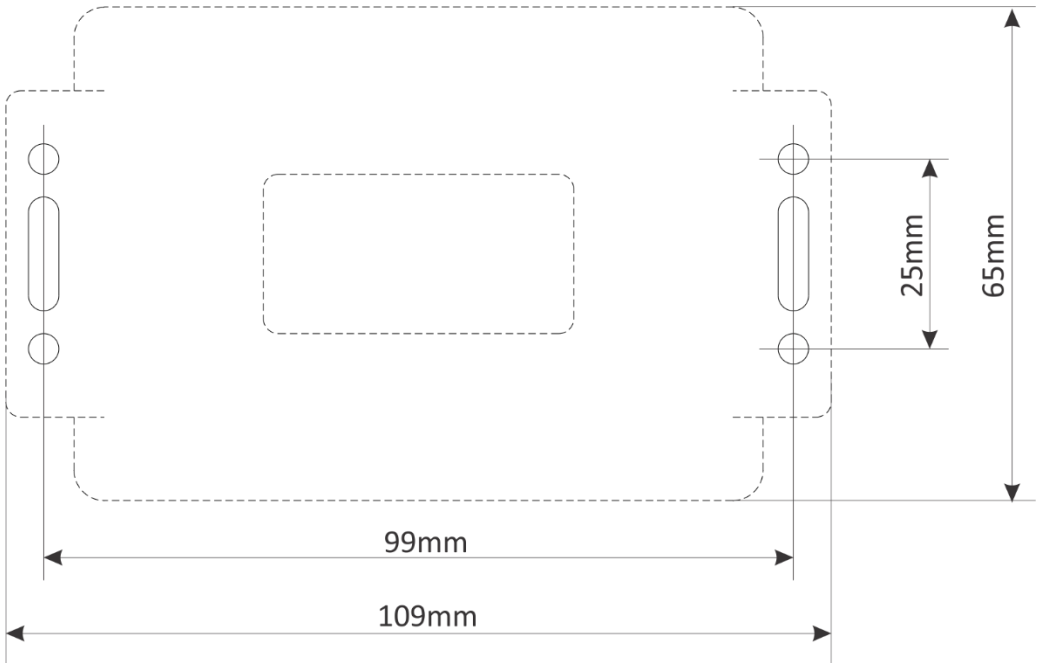

Fig.1

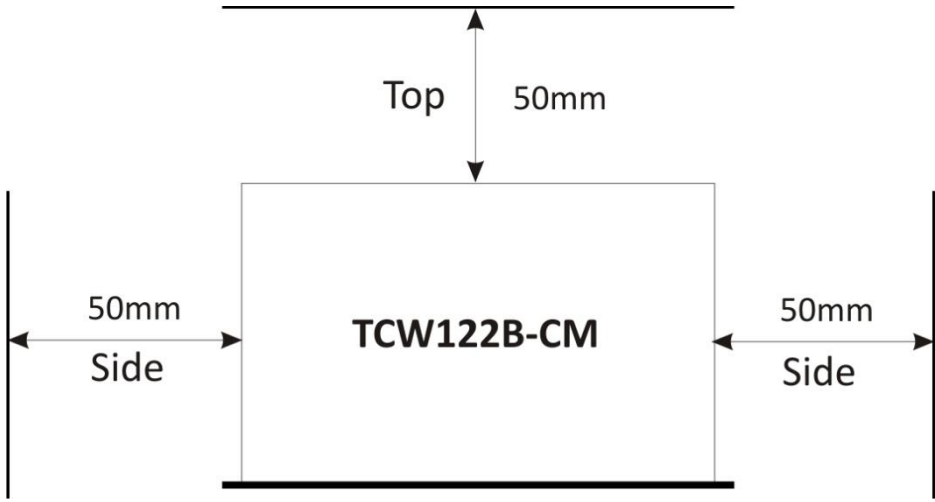

Fig.2