

LabCon



PPI

The Perfection Experts

Multi-Purpose Temperature Controller Recording + 4 Channel Mapping + PC Software



User Manual

CONTENTS

1. FRONT PANEL LAYOUT	1
2. BASIC OPERATION	2
3. OPERATOR PARAMETERS	6
4. SUPERVISORY PARAMETERS	8
5. FACTORY PARAMETER	14
6. PANEL MOUNTING AND ELECTRICAL CONNECTIONS	25
APPENDIX-A : DC LINEAR SIGNAL INTERFACE	29

Section 1 FRONT PANEL LAYOUT

The Controller front panel comprises of Graphic Readout and Membrane Keys as shown in Figure 1.1 below.

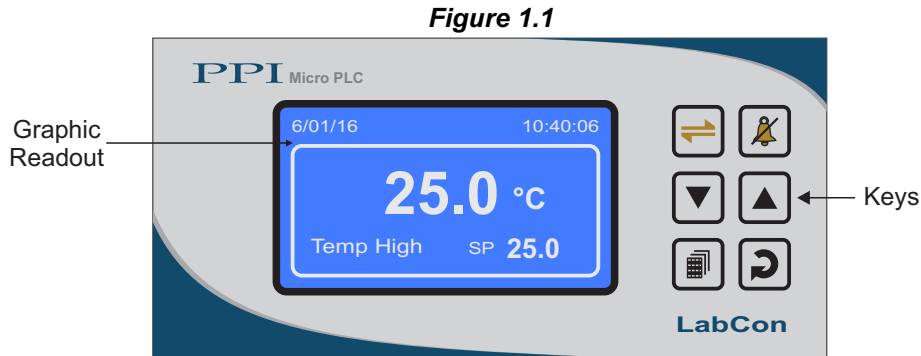

GRAPHIC READOUT

The Graphic Readout is a 160 X 80 Pixel Monochrome LCD Display. In Normal operation mode the Readout shows measured Temperature Value, Set Temperature Value, Alarm / Process Status, Elapsed Soak Time (if enabled & running) & Date/Time. Other process information like Mapping Channels PVs / Alarm Status, Process Status & Stored Records can be viewed using screen scroll feature.

In Set-up Mode, the Readout displays parameter names and values that can be edited using front keys.

KEYS

There are six tactile keys provided on the front panel for configuring the controller and setting-up the parameter values. The Table 1.1 below lists each key (identified by the front panel symbol) and the associated function.

Table 1.1

Symbol	Key	Function
	Scroll	Press to scroll through various Process Information Screens in Normal Operation Mode.
	Alarm Acknowledge	Press to acknowledge and mute (if active) alarm output.
	DOWN	Press to decrease the parameter value. Pressing once decreases the value by one count; keeping pressed speeds up the change.
	UP	Press to increase the parameter value. Pressing once increases the value by one count; keeping pressed speeds up the change.
	SET-UP	Press to enter or exit set-up mode.
	ENTER	Press to store the set parameter value and to scroll to the next parameter.

Section 2 BASIC OPERATIONS

POWER-UP DISPLAY

Figure 2.1 (a)

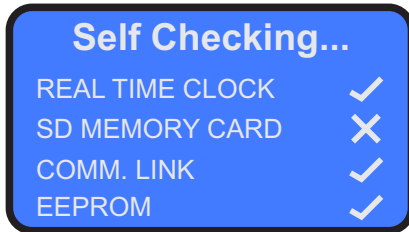



Figure 2.1 (b)



Upon power-up the controller display shows screen depicted in Figure 2.1(a) for 2 Seconds. The controller runs through a self-test sequence for checking its Real Time Clock, SD Memory Card, internal Communication Link and Parameter Storage Memory (EEPROM). The ✓ and ✗ symbols indicate whether a check is passed or failed, respectively. In case any one or more checks fail, the controller starts executing its normal operation but ‘Self Checking’ screen is halted until front panel “Acknowledge” key is pressed. This is followed by screen depicted in Figure 2.1(b) for next 2 Seconds. This screen shows the controller model name, Hardware Version and Firmware Version.

RUN MODE

After the Power-up display sequence the controller enters into RUN Mode. This is the normal operation mode wherein the controller starts PV measurements, Alarm monitoring and Control Loop execution. The Display comprises of several screens described below. The screens appear one-after-the-other upon pressing  (Scroll) Key while in RUN Mode.

Main Screen

Figure 2.2 (a)



Figure 2.2 (b)

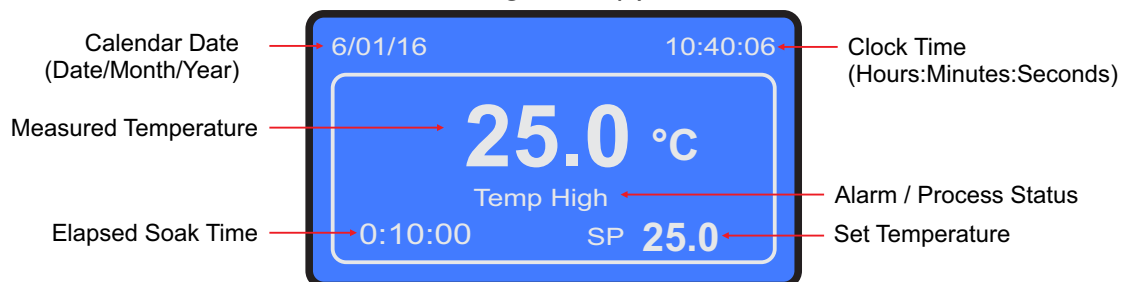

This is the default Run Mode screen that shows Measured Temperature Value, Set Temperature Value, Calendar Date, Clock Time and Alarm / Process Status as illustrated in Figure 2.2 (a) above.

If Soak Timer function is enabled, the Run Mode screen also shows the elapsed time as illustrated in Figure 2.2 (b) above.

In case of measured value errors, the messages listed in Table 2.1 flash in place of process value as illustrated in Figure 2.3.

Table 2.1

Message	Error Type	Cause
OPEN	Sensor Open	Sensor (RTD Pt100) Broken / Open
OVR	Over-range	Temperature above Max. Specified Range
UNR	Under-range	Temperature below Min. Specified Range

Figure 2.3

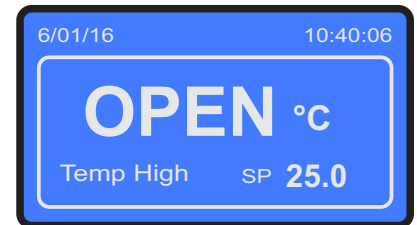

The Alarm / Process Status space on the screen may show one or more of the several messages listed in Table 2.2 depending upon the existence of active alarms or process events. In case of co-existence of multiple active alarms or process events, the messages are scrolled one after the other with an approximate time interval of 3 seconds. Also if there is no active alarm or process event, the message space is blank.

Table 2.2

Message String	Alarm / Process Status
Temp High	The measured temperature at Control Channel is in Process High Alarm State.
Temp Low	The measured temperature at Control Channel is in Process Low Alarm State.
Map-x High	The measured temperature at Mapping Channel 'x' (x = 1, 2, 3 or 4) is in Process High Alarm State.
Map-x Low	The measured temperature at Mapping Channel 'x' (x = 1, 2, 3 or 4) is in Process Low Alarm State.
Tuning	The Controller is Self Tuning.
Mains Fail	The Controller is operating on Standby Power Source like battery or inverter.
Door Open	The Equipment / Chamber door is open for a time longer than the set 'DOORALRM DLY' time.

Mapping Status Screen

Figure 2.4

MAPPING STATUS		
MAP	PV °C	ALARM
1	25.1	Normal
2	24.4	Low
3	25.0	Normal
4	25.4	High

The Mapping Status Screen is shown upon pressing  (Scroll) key from Main Screen.

The Controller provides up to 3 or 4 mapping channels. The Mapping Status Screen is available only if the controller is configured for at least one mapping channel. The mapping status screen for 4 mapping channels is shown in the figure 2.4. In case lesser mapping channels are configured, the skipped channels are not shown on the screen.

Process Status Screen



The Process Status Screen is shown upon pressing  (Scroll) key from Main Screen or upon acknowledging a new Alarm by pressing  (Acknowledge) key. As depicted in Figure 2.5; the screen shows Temperature Alarm Status, Door Open / Close Status, the Heater Output (Heating) in % & Compressor ON / OFF Status.

Figure 2.5

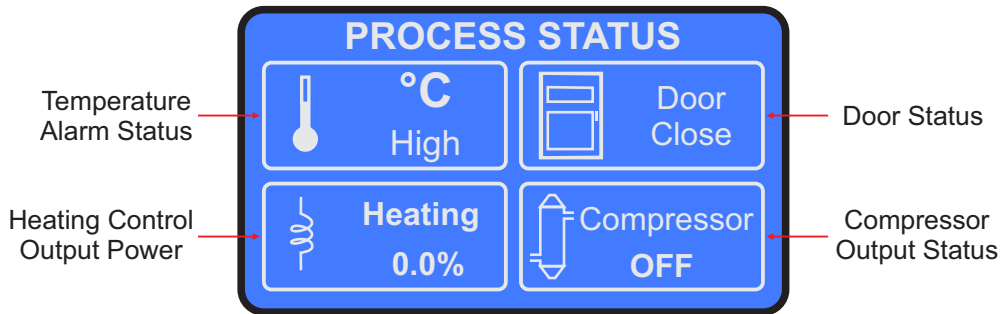

Figure 2.5 (a)

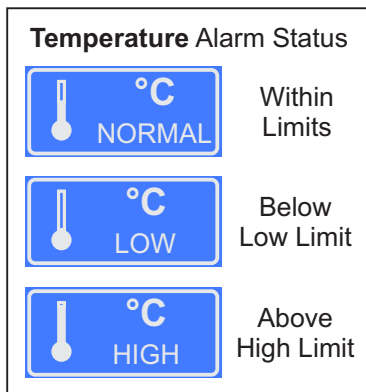
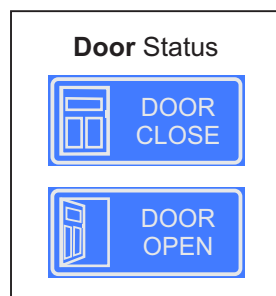

Figure 2.5 (b)



The Controller provides programmable Low & High deviation limits around the temperature control setpoint to monitor Alarm conditions. The screen shows either NORMAL or LOW or HIGH Status, as shown in Figure 2.5 (a) depending upon the deviation of measured temperature value from the control setpoint and set limits.

The Controller provides a Digital Input for interfacing Door switch that senses the door position, Open or Close. The screen indicates the door status as shown in Figure 2.5 (b).

Record View Screen



The Record View Screen is shown upon pressing  (Scroll) key from Process Status Screen. This screen facilitates viewing of up to most recent 1000 stored records. The records can be scrolled for viewing using  (UP) &  (DOWN) keys. As depicted in Figure 2.6; the record view screen comprises Date & Time stamps, PV, SP & Alarm Status for Control Channel. If Mapping Channels are configured, the recorded Process Values & Alarm Status for configured mapping channels are also shown. The Record Number format shows both, the sequential number for the selected record & the total numbers of records available for viewing (for example; 1/21 means the sequential record number is 1 & the total available records are 21).



Figure 2.6

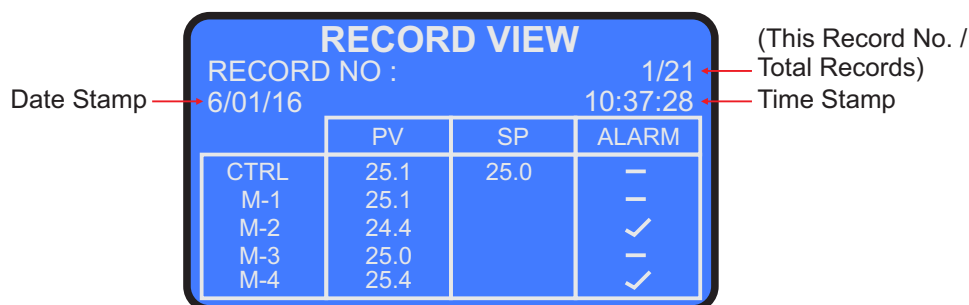
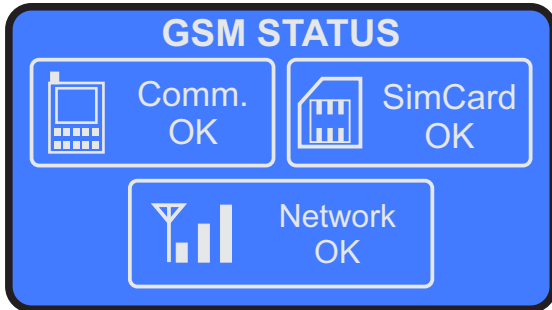

GSM Status Screen (for GSM Module option only)

Figure 2.7



 Comm. Error	The communication link between the controller & GSM Module is broken.
 SimCard Error	The SIM card is either missing or not inserted properly.
 Network Error	No Network connection.

The GSM Status Screen is shown upon pressing  (Scroll) key from Output Status Screen.



Section 3 OPERATOR PARAMETERS

The Operator Parameters are accessible under PASSWORD 0. The list includes parameters for adjusting Control Setpoint, Alarm Setpoints & Zero-offset for Control & Mapping Channels. If Soak Timer is enabled then Time Interval value & Timer Start / Abort commands are also available.

The Figure 3.1 shows how to access Operator Parameters. The Example illustrates changing the Low Deviation alarm value from 2.0 to 5.0 for control channel. (The Example is shown with Soak Timer disabled).

Figure 3.1

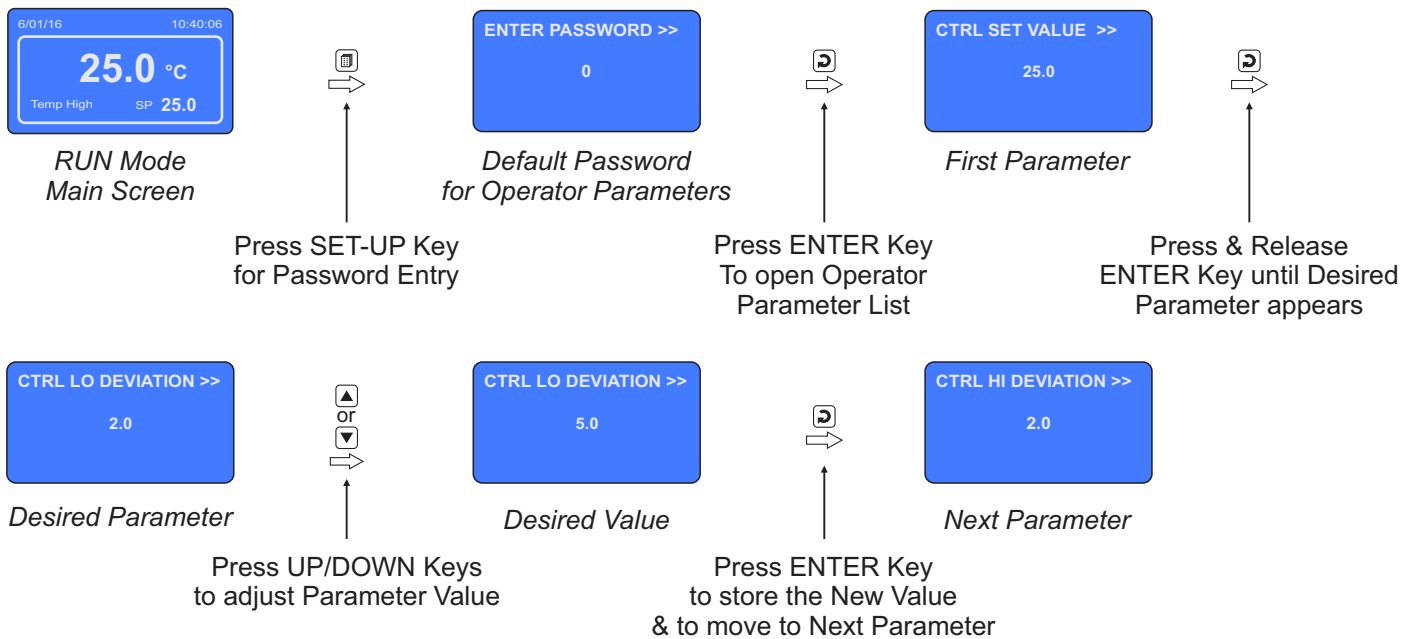

The Table 3.1 below described the Operator Parameters in detail.

Table 3.1

Parameter Description	Settings (Default Value)
<p>TIME START COMMAND >> TIME ABORT COMMAND >> <i>(Available only if Soak Timer is Enabled)</i></p> <p>These two commands are mutually exclusive.</p> <p>Set to Yes to start Soak Timer, if not already started.</p> <p>Set to Yes to abort a running timer.</p>	<p>Yes No (Default : No)</p>
<p>TIME INTERVAL (H:M) >> <i>(Available only if Soak Timer is Enabled)</i></p> <p>The set time value for the soak timer in Hours : Minutes.</p>	<p>0.00 to 500.00 (HH:MM) (Default : 0.10)</p>

Parameter Description	Settings (Default Value)
<p>CTRL SET VALUE >></p> <p>This parameter sets the value at which the controller attempts to maintain the measured temperature value.</p>	<p>Setpoint LO limit to Setpoint HI limit (Resolution 0.1°C for RTD / DC Linear & 1°C for Thermocouple) (Default : 25.0)</p>
<p>CTRL LO DEVIATION >></p> <p>This Parameter sets a negative deviation (offset) limit with respect to the 'Control Set-point'. The Alarm is activated if the measured temperature value falls below this limit.</p>	<p>For RTD & DC Linear : 0.2 to 99.9 For Thermocouple : 2 to 99 (Default : 2.0)</p>
<p>CTRL HI DEVIATION >></p> <p>This Parameter sets a negative deviation (offset) limit with respect to the 'Control Set-point'. The Alarm is activated if the measured temperature value exceeds this limit.</p>	<p>For RTD & DC Linear : 0.2 to 99.9 For Thermocouple : 2 to 99 (Default : 2.0)</p>
<p>CHANGE PASSWORD >></p> <p>The Controller is shipped from the factory with a default password (0) for accessing the parameters reserved for Operator. However, if required the password can be changed by setting the new value for this parameter.</p> <p>(The new password replaces the old password. That is, the old password is no longer valid. it is user's responsibility to memorize the password.)</p>	<p>1 to 100 (Default : 0)</p>



Section 4 SUPERVISORY PARAMETERS

The various parameters have been assembled in different groups under the default factory password 123.

Refer Table 4.1 below for a quick summary of parameters under different groups. Each parameter has been described in subsequent sections.

Table 4.1

Group	Parameters
Sensor Input	Control Zero Offset, Mapping 1 Zero Offset, Mapping 2 Zero Offset, Mapping 3 Zero Offset, Mapping 4 Zero Offset
Recording	Record Interval (Min), Alarm Toggle Record, Delete PC Records, Delete Display Records, GSM Machine ID, RTC Time, RTC Date, RTC Month, RTC Year, Device ID
Control	Tune, Setpoint Low Limit, Setpoint High Limit, Compressor Setpoint Compressor Hysteresis, Heat Control Action, Heat Hysteresis, CZ Proportional Band, CZ Integral Time, CZ Derivative Time, HZ Proportional Band, HZ Integral Time, HZ Derivative Time, Cycle Time
Password	Change Password
Exit	Exit Set-up Mode (Yes / No)

Accessing Group & Parameters

The Figure 4.1 below illustrates how to access the group and parameters. The example shows changing the value for the parameter 'Setpoint High Limit' from 600.0 to 100.0 that is located under group 'Control'.

Figure 4.1

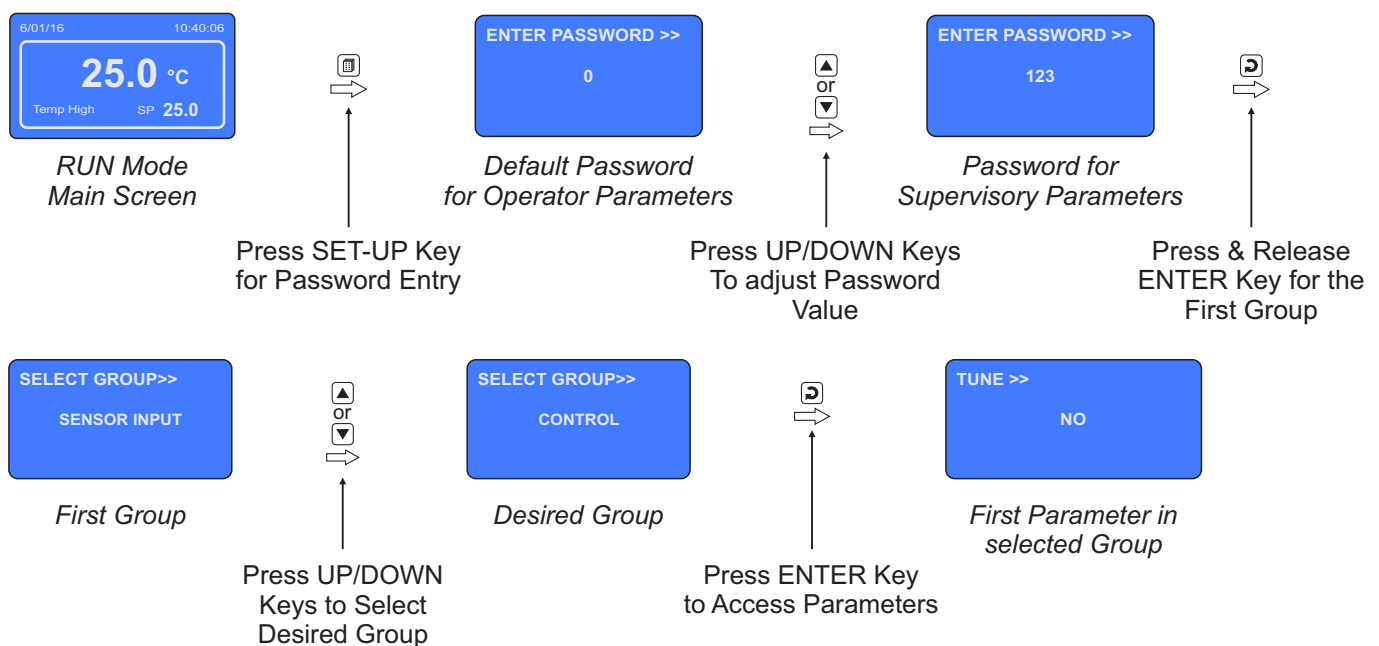

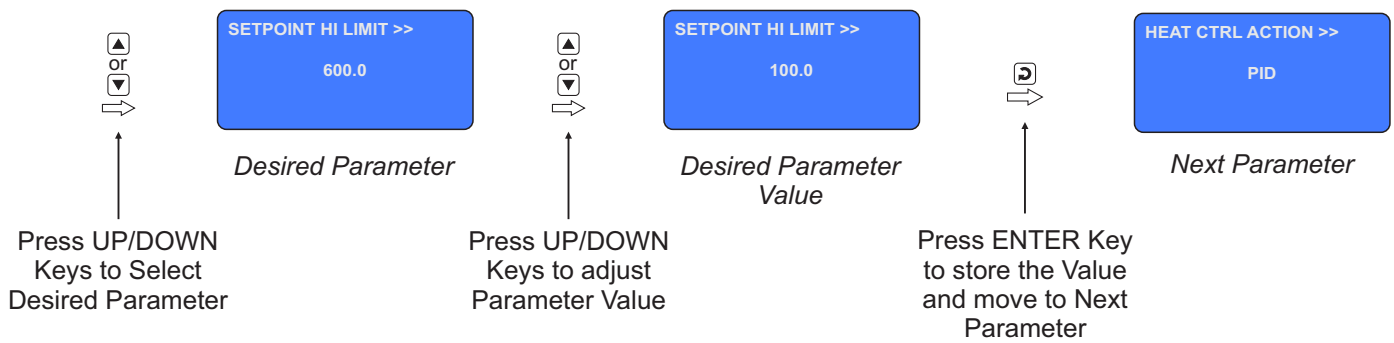

Notes

1. The Last Parameter in the selected Group rolls back to the 'SELECT GROUP' screen again to avoid re-entering the password in case multiple parameters need to be set under the selected Group.
2. Select group 'EXIT' & set parameter 'EXIT SET-UP MODE' to 'YES' for returning to Main Display Mode. Alternately use Setup Key for instant revert to Main Display Mode.

Parameter Descriptions

The various Supervisory Parameters have been described with their respective group & sub-group.

SUPERVISORY > SENSOR INPUT

Parameter Description	Settings (Default Value)
<p>CTRL ZERO OFFSET >></p> <p>This value is algebraically added to the measured Temperature Value at control channel to derive the final value that is displayed and compared for alarm / control. Use this value to nullify any known constant error.</p> <p>Final Value = Measured Value + Offset</p>	<p>-50 to 50 (Resolution 0.1°C for RTD / DC Linear & 1°C for Thermocouple) (Default : 0.0)</p>
<p>MAP-1 ZERO OFFSET >> MAP-2 ZERO OFFSET >> MAP-3 ZERO OFFSET >> MAP-4 ZERO OFFSET >></p> <p>Same as Control Zero Offset but applied to Mapping Channels 1 to 4, respectively.</p>	<p>-50 to 50 (Resolution 0.1°C for RTD / DC Linear & 1°C for Thermocouple) (Default : 0.0)</p>

SUPERVISORY > RECORDING

Parameter Description	Settings (Default Value)
<p>REC. INTERVAL (MIN) >> The Controller generates and stores periodic records at the interval set by this parameter. The time units are in Minutes.</p> <p>Setting this parameter value to 0 disables normal recording.</p>	<p>0 to 250 Min (Default : 5 Min)</p>
<p>ALRM TOGGLE RECORD >> If this parameter is set to 'Enable', the Controller generates and stores a record each time either the temperature or %RH alarm toggles the status (On-to-Off or Off-to-On).</p>	<p>ENABLE DISABLE (Default : ENABLE)</p>
<p>DEL PC RECORDS >> This parameter is a command that allows the user to delete all the records from the controller memory that are meant for uploading to remote PC. Set the parameter to "YES" to carry out delete operation.</p>	<p>YES NO (Default : NO)</p>
<p>DEL DISPLAY RECORD >> This parameter is a command that allows the user to delete all the records from the controller memory that are meant for displaying on the controller screen using 'Record View'. Set the parameter to "YES" to carry out delete operation.</p>	<p>YES NO (Default : NO)</p>
<p>GSM MACHINE ID >> (Available only if the controller is supplied with GSM Module Version)</p> <p>This parameter can be used to assigned a unique ID to the machine (chamber) to identify the source of SMS alert.</p>	<p>1 to 128 (Default : 1)</p>
<p>RTC TIME >> Set current clock time in Hrs:Min (24 Hours format).</p>	<p>0 to 23 for Hour 0 to 59 for Min (Default : NA)</p>
<p>RTC DATE >> Set current calendar date.</p>	<p>1 to 31 (Default : NA)</p>
<p>RTC MONTH >> Set current calendar month.</p>	<p>1 to 12 (Default : NA)</p>
<p>RTC YEAR >> Set current calendar year.</p>	<p>2000 to 2099 (Default : NA)</p>
<p>DEVICE ID >> (Applicable for Serial Communication)</p> <p>Unique numeric code assigned to the indicator for identification by the remote PC. Set the value as required by the remote PC.</p>	<p>1 to 127 (Default : 1)</p>

SUPERVISORY > CONTROL

Parameter Description	Settings (Default Value)
<p>TUNE >> (Available for Heat Only / Heat+Cool Control Strategy)</p> <p>Set 'Yes' to activate and 'No' to abort the Tuning operation.</p>	<p>Yes No (Default : No)</p>
<p>SETPOINT LO LIMIT >></p> <p>This parameter sets the minimum limit on the Control Setpoint value.</p>	<p>Min Range for the Selected Input Type to Setpoint HI Limit (Resolution 0.1°C for RTD / DC Linear & 1°C for Thermocouple) (Default : 0.0)</p>
<p>SETPOINT HI LIMIT >></p> <p>This parameter sets the maximum limit on the Control Setpoint value.</p>	<p>Setpoint LO Limit to Max Range for the Selected Input Type (Resolution 0.1°C for RTD / DC Linear & 1°C for Thermocouple) (Default : 600.0)</p>
<p>COMPRESSOR SETPOINT >> (Available for 'Heat + Cool' Control with Compressor PV based Strategy)</p> <p>This Setpoint Value is compared with the Process Value to switch the compressor On/Off with the set compressor hysteresis.</p>	<p>0 to 100 (Resolution 0.1°C for RTD / DC Linear & 1°C for Thermocouple) (Default : 45.0)</p>
<p>COMPRESSOR HYST >> (Available for 'Cool Only' & 'Heat + Cool' Control with Compressor PV based Strategy)</p> <p>Differential (dead) band between the compressor ON and OFF states.</p>	<p>0.1 to 99.9 (Default : 2.0)</p>
<p>HEAT CTRL ACTION >> (Available for 'Heat Only' & 'Heat+Cool' Control Strategy)</p> <p><i>On-Off</i> The control algorithm tends to maintain the PV at SP by either switching the output (say, Heater) fully OFF or fully ON. The On and Off switching is differentiated by the user settable 'Hysteresis Band'.</p> <p><i>PID</i> The control algorithm uses a 2nd order equation to compute the '% Output Power' required to maintain the PV at SP. The constants P, I, D are automatically set by the controller.</p>	<p>ON-OFF PID (Default : PID)</p>
<p>HEAT HYST >> (Available for 'ON-OFF' Heat Control Action)</p> <p>Sets a differential (dead) band between the ON and OFF states. Keep it large enough to avoid frequent switching of the load without losing the desired control accuracy.</p>	<p>0.1 to 99.9 (Default : 0.2)</p>

Heat Only Control	Heat + Cool Control Zone : Single	Heat + Cool Control Zone : Dual
<p>PROPORTIONAL BAND >> 0.1 to 999.9 (Default : 50.0)</p>	<p>PROPORTIONAL BAND >> 0.1 to 999.9 (Default : 50.0)</p>	<p>CZ PROP BAND >> <i>Proportional Band for Cool Pre-dominant zone</i> 0.1 to 999.9 (Default : 50.0)</p>
<p>INTEGRAL TIME >> 0 to 3600 sec (Default : 100 sec)</p>	<p>INTEGRAL TIME >> 0 to 3600 sec (Default : 100 sec)</p>	<p>CZ INTEGRAL TIME >> <i>Integral Time for Cool Pre-dominant zone</i> 0 to 3600 sec (Default : 100 sec)</p>
<p>DERIVATIVE TIME >> 0 to 600 sec (Default : 16 sec)</p>	<p>DERIVATIVE TIME >> 0 to 600 sec (Default : 16 sec)</p>	<p>CZ DERIVATIVE TIME >> <i>Derivative Time for Cool Pre-dominant zone</i> 0 to 600 sec (Default : 16 sec)</p>
<p>CYCLE TIME >> 0.5 to 100.0 sec (Default : 10.0 sec)</p>	<p>CYCLE TIME >> 0.5 to 100.0 sec (Default : 10.0 sec)</p>	<p>HZ PROP BAND >> <i>Proportional Band for Heat Pre-dominant zone</i> 0.1 to 999.9 (Default : 50.0)</p>
<p>OVERSHOOT INHIBIT >> Enable Disable (Default : Disable)</p>	<p>OVERSHOOT INHIBIT >> Enable Disable (Default : Disable)</p>	<p>HZ INTEGRAL TIME >> <i>Integral Time for Heat Pre-dominant zone</i> 0 to 3600 sec (Default : 100 sec)</p>
<p>CUTOFF FACTOR >> 1.0 to 2.0 sec (Default : 1.2 sec)</p>	<p>CUTOFF FACTOR >> 1.0 to 2.0 sec (Default : 1.2 sec)</p>	<p>HZ DERIVATIVE TIME >> <i>Derivative Time for Heat Pre-dominant zone</i> 0 to 600 sec (Default : 16 sec)</p>
		<p>CYCLE TIME >> 0.5 to 100.0 sec (Default : 10.0 sec)</p>
		<p>OVERSHOOT INHIBIT >> Enable Disable (Default : Disable)</p>
		<p>CUTOFF FACTOR >> 1.0 to 2.0 sec (Default : 1.2 sec)</p>

PROPORTIONAL BAND

Sets proportional gain (% power per unit error). Defined in same units and resolution as that for PV.

INTEGRAL TIME

Sets integral time constant in Seconds. Setting the value to 0, cuts-off the integral action.

DERIVATIVE TIME

Sets derivative time constant in seconds. Setting the value to 0, cuts-off the derivative action.

CYCLE TIME

Sets the total 'On + Off' time in seconds for time proportional power output through Relay / SSR for OP1.

OVERSHOOT INHIBIT

Set this parameter to 'Enable' if the process exhibits unacceptable overshoot upon start-up or a step change in SP. If enabled, the controller controls the rate of change of PV to minimize overshoot while approaching the target SP.

CUTOFF FACTOR

This parameter adjusts the effectiveness of the Overshoot Inhibit feature. Increase the value if the overshoot is curbed but the PV takes longer to reach the SP. Decreases the value if the overshoot persists.

SUPERVISORY > PASSWORD

Parameter Description	Settings (Default Value)
<p>CHANGE PASSWORD >></p> <p>The Controller is shipped from the factory with a default password (123) for accessing the parameters reserved for the equipment manufacturer. However, if required the password can be changed by setting the new value for this parameter.</p> <p>(The new password replaces the old password. That is, the old password is no longer valid. it is user's responsibility to memorize the password.)</p>	<p>1000 to 1999 (Default : 123)</p>

SUPERVISORY > EXIT

Parameter Description	Settings (Default Value)
<p>EXIT SETUP MODE >></p> <p>Select 'Yes' to quit <i>Setup</i> mode and return to <i>Main Display</i> mode.</p>	<p>YES NO (Default : NO)</p>



Section 5 FACTORY PARAMETERS

The various parameters have been assembled in various group under the default factory password 321.

Refer Table 5.1 below for a quick summary of parameters under different groups. Each parameter has been described in subsequent sections.

Table 5.1

Group	Parameters
Control Sensor Input	Input Type, Signal Low, Signal High, Range low, Range High
Mapping	Mapping Points, Input Type, Signal Low, Signal High, Range low, Range High
Alarm	Hysteresis, Inhibit
Heat Cool Select	Control Strategy, Compressor Strategy, Boundary Set Value, Control Zones, Time Delay (Sec)
Soak Timer	Enable, Start Band, Holdback Strategy, Hold Band, Heat Off, Cool Off, Power Recovery
Door Open	Enable/Disable, Switch Logic, Door Alarm Delay
Mains Failure	Enable/Disable, Switch Logic
SMS Alert	Enable/Disable, Reset GSM Module, Map SMS Enable
Password	Change Password
Factory Default	Set to Default Yes/No
Exit	Exit Set-up Mode Yes/No

Accessing Group & Parameters

The Figure 5.1 below illustrates how to access the group and parameters. The example shows changing the value for the parameter 'Hysteresis' that is located under group 'Alarm' from 0.2°C to 0.5°C.

Figure 5.1

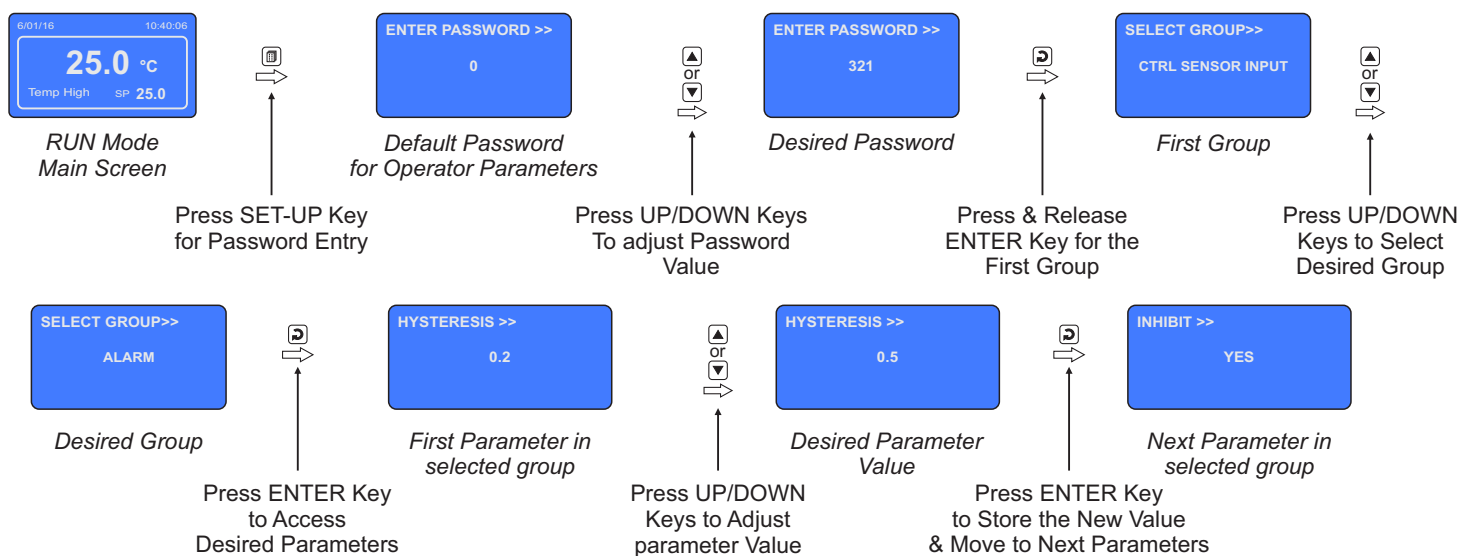

Notes

1. The Last Parameter in the selected Group rolls back to the 'SELECT GROUP' screen again to avoid re-entering the password in case multiple parameters need to be set under different Group.
2. Select group 'EXIT' & set parameter 'EXIT SET-UP MODE' to 'YES' for returning to Main Display Mode. Alternately use Set-up Key for instant revert to Main Display Mode.

Parameter Descriptions

The various Factory Parameters have been described with their respective group & sub-group.

FACTORY > CONTROL SENSOR INPUT

Parameter Description	Settings (Default Value)																		
<p>INPUT TYPE >> Select Input type in accordance with the type of Temperature sensor / transmitter connected for measurement.</p>	<p>Refer Table 5.2 (Default : RTD Pt100)</p>																		
<p>SIGNAL LO >> <i>(Available for DC linear V & mA Inputs only)</i> The transmitter output signal value corresponding to Range Low process value. Refer <i>Appendix-A : DC Linear Signal Interface</i> for details.</p>	<table border="1" style="width: 100%; border-collapse: collapse;"> <thead> <tr> <th>Input Type</th> <th>Settings</th> <th>Default</th> </tr> </thead> <tbody> <tr> <td>0 to 20 mA</td> <td>0.00 to Signal High</td> <td>0.00</td> </tr> <tr> <td>4 to 20 mA</td> <td>4.00 to Signal High</td> <td>4.00</td> </tr> <tr> <td>0 to 5 V</td> <td>0.000 to Signal High</td> <td>0.000</td> </tr> <tr> <td>0 to 10 V</td> <td>0.00 to Signal High</td> <td>0.00</td> </tr> <tr> <td>1 to 5 V</td> <td>1.000 to Signal High</td> <td>1.000</td> </tr> </tbody> </table>	Input Type	Settings	Default	0 to 20 mA	0.00 to Signal High	0.00	4 to 20 mA	4.00 to Signal High	4.00	0 to 5 V	0.000 to Signal High	0.000	0 to 10 V	0.00 to Signal High	0.00	1 to 5 V	1.000 to Signal High	1.000
Input Type	Settings	Default																	
0 to 20 mA	0.00 to Signal High	0.00																	
4 to 20 mA	4.00 to Signal High	4.00																	
0 to 5 V	0.000 to Signal High	0.000																	
0 to 10 V	0.00 to Signal High	0.00																	
1 to 5 V	1.000 to Signal High	1.000																	
<p>SIGNAL HI >> <i>(Available for DC linear V & mA Inputs only)</i> The transmitter output signal value corresponding to Range High process value. Refer <i>Appendix-A : DC Linear Signal Interface</i> for details.</p>	<table border="1" style="width: 100%; border-collapse: collapse;"> <thead> <tr> <th>Input Type</th> <th>Settings</th> <th>Default</th> </tr> </thead> <tbody> <tr> <td>0 to 20 mA</td> <td>Signal Low to 20.00</td> <td>20.00</td> </tr> <tr> <td>4 to 20 mA</td> <td>Signal Low to 20.00</td> <td>20.00</td> </tr> <tr> <td>0 to 5 V</td> <td>Signal Low to 5.000</td> <td>5.000</td> </tr> <tr> <td>0 to 10 V</td> <td>Signal Low to 10.00</td> <td>10.00</td> </tr> <tr> <td>1 to 5 V</td> <td>Signal Low to 5.000</td> <td>5.000</td> </tr> </tbody> </table>	Input Type	Settings	Default	0 to 20 mA	Signal Low to 20.00	20.00	4 to 20 mA	Signal Low to 20.00	20.00	0 to 5 V	Signal Low to 5.000	5.000	0 to 10 V	Signal Low to 10.00	10.00	1 to 5 V	Signal Low to 5.000	5.000
Input Type	Settings	Default																	
0 to 20 mA	Signal Low to 20.00	20.00																	
4 to 20 mA	Signal Low to 20.00	20.00																	
0 to 5 V	Signal Low to 5.000	5.000																	
0 to 10 V	Signal Low to 10.00	10.00																	
1 to 5 V	Signal Low to 5.000	5.000																	
<p>RANGE LO >> <i>(Available for DC linear V & mA Inputs only)</i> The process value corresponding to the Signal Low value from the transmitter. Refer <i>Appendix-A : DC Linear Signal Interface</i> for details.</p>	<p>-199.9 to RANGE HI (Default : 0.0)</p>																		
<p>RANGE HI >> <i>(Available for DC linear V & mA Inputs only)</i> The process value corresponding to the Signal High value from the transmitter. Refer <i>Appendix-A : DC Linear Signal Interface</i> for details.</p>	<p>RANGE LO to 999.9 (Default : 100.0)</p>																		

FACTORY > MAPPING PARAMETERS

Parameter Description	Settings (Default Value)																		
<p>MAPPING POINTS >></p> <p>The Controller supports up to 3 or 4 sensor inputs (depending on version supplied) for Mapping. This parameter allows the user to select the desired numbers for Mapping. Selecting 0 disables any mapping.</p>	<p>0 to 4 (Default : 0)</p>																		
<p>INPUT TYPE >></p> <p>Select Input type in accordance with the type of Temperature sensor / transmitters connected for mapping. Note that all inputs must have the same sensor or transmitter type.</p>	<p>Refer Table 5.2 (Default : RTD Pt100)</p>																		
<p>SIGNAL LO >></p> <p>The transmitter output signal value corresponding to Range Low process value. Refer <i>Appendix-A : DC Linear Signal Interface</i> for details.</p>	<table border="1"> <thead> <tr> <th>Input Type</th> <th>Settings</th> <th>Default</th> </tr> </thead> <tbody> <tr> <td>0 to 20 mA</td> <td>0.00 to Signal High</td> <td>0.00</td> </tr> <tr> <td>4 to 20 mA</td> <td>4.00 to Signal High</td> <td>4.00</td> </tr> <tr> <td>0 to 5 V</td> <td>0.000 to Signal High</td> <td>0.000</td> </tr> <tr> <td>0 to 10 V</td> <td>0.00 to Signal High</td> <td>0.00</td> </tr> <tr> <td>1 to 5 V</td> <td>1.000 to Signal High</td> <td>1.000</td> </tr> </tbody> </table>	Input Type	Settings	Default	0 to 20 mA	0.00 to Signal High	0.00	4 to 20 mA	4.00 to Signal High	4.00	0 to 5 V	0.000 to Signal High	0.000	0 to 10 V	0.00 to Signal High	0.00	1 to 5 V	1.000 to Signal High	1.000
Input Type	Settings	Default																	
0 to 20 mA	0.00 to Signal High	0.00																	
4 to 20 mA	4.00 to Signal High	4.00																	
0 to 5 V	0.000 to Signal High	0.000																	
0 to 10 V	0.00 to Signal High	0.00																	
1 to 5 V	1.000 to Signal High	1.000																	
<p>SIGNAL HI >></p> <p>The transmitter output signal value corresponding to Range High process value. Refer <i>Appendix-A : DC Linear Signal Interface</i> for details.</p>	<table border="1"> <thead> <tr> <th>Input Type</th> <th>Settings</th> <th>Default</th> </tr> </thead> <tbody> <tr> <td>0 to 20 mA</td> <td>Signal Low to 20.00</td> <td>20.00</td> </tr> <tr> <td>4 to 20 mA</td> <td>Signal Low to 20.00</td> <td>20.00</td> </tr> <tr> <td>0 to 5 V</td> <td>Signal Low to 5.000</td> <td>5.000</td> </tr> <tr> <td>0 to 10 V</td> <td>Signal Low to 10.00</td> <td>10.00</td> </tr> <tr> <td>1 to 5 V</td> <td>Signal Low to 5.000</td> <td>5.000</td> </tr> </tbody> </table>	Input Type	Settings	Default	0 to 20 mA	Signal Low to 20.00	20.00	4 to 20 mA	Signal Low to 20.00	20.00	0 to 5 V	Signal Low to 5.000	5.000	0 to 10 V	Signal Low to 10.00	10.00	1 to 5 V	Signal Low to 5.000	5.000
Input Type	Settings	Default																	
0 to 20 mA	Signal Low to 20.00	20.00																	
4 to 20 mA	Signal Low to 20.00	20.00																	
0 to 5 V	Signal Low to 5.000	5.000																	
0 to 10 V	Signal Low to 10.00	10.00																	
1 to 5 V	Signal Low to 5.000	5.000																	
<p>RANGE LO >></p> <p>The process value corresponding to the Signal Low value from the transmitter. Refer <i>Appendix-A : DC Linear Signal Interface</i> for details.</p>	<p>-199.9 to RANGE HI (Default : 0.0)</p>																		
<p>RANGE HI >></p> <p>The process value corresponding to the Signal High value from the transmitter. Refer <i>Appendix-A : DC Linear Signal Interface</i> for details.</p>	<p>RANGE LO to 999.9 (Default : 100.0)</p>																		

Table 5.2

What it means	Range (Min. to Max.)	Resolution
Type J Thermocouple	0 to +960°C	Fixed 1°C
Type K Thermocouple	-200 to +1376°C	
Type T Thermocouple	-200 to +385°C	
Type R Thermocouple	0 to +1770°C	
Type S Thermocouple	0 to +1765°C	
Type B Thermocouple	0 to +1825°C	
Type N Thermocouple	0 to +1300°C	
Reserve	Reserved for customer specific Thermocouple type not listed above. The type shall be specified in accordance with the ordered (optional on request) Thermocouple type.	
3-wire, RTD Pt100	-199.9 to 600.0°C	Fixed 0.1°C
0 to 20mA DC current	-199.9 to 999.9 units	Fixed 0.1 unit
4 to 20mA DC current		
0 to 5.0V DC voltage		
0 to 10.0V DC voltage		
1 to 5.0V DC voltage		

FACTORY > ALARM PARAMETERS

Parameter Description	Settings (Default Value)
<p>HYSTERESIS >></p> <p>This parameter sets a differential (dead) band between the ON and OFF Alarm status change. Keep it large enough to avoid frequent switching of the Alarm Status/Relay.</p>	<p>0.1 to 99.9 (Default : 0.2)</p>
<p>INHIBIT >></p> <p><i>Yes</i> The Alarm activation is suppressed until the Temperature value is within Alarm limits from the time the controller is switched ON. This allows suppressing the Alarm during the start-up Alarm conditions.</p> <p><i>No</i> The Alarm is not suppressed during the start-up Alarm conditions.</p>	<p>YES NO (Default : YES)</p>

FACTORY > HEAT COOL SELECT

The PPI “Multi-Purpose Temperature Controller” provides control outputs for driving, both, heating & cooling sources. The user can enable any one or both outputs depending upon the test equipment type and application. If both outputs are enabled (by setting the parameter ‘Control Strategy’ to *Heat + Cool*) and if the cooling source is compressor then the controller offers various strategies for switching the compressor as described below.

Compressor Switching Strategies

1. Compressor Off

The compressor is kept Off. This strategy is usually selected for temperature values significantly above the ambient temperature.

2. Compressor On

The compressor is kept On regardless of the measured or set temperature value. This strategy is usually selected for temperature values significantly below the ambient temperature.

3. SP Based Strategy

In this strategy, the chamber temperature range is split in two zones by setting the parameter ‘Boundary Set-point’ (BSP). Refer Figure 5.2.

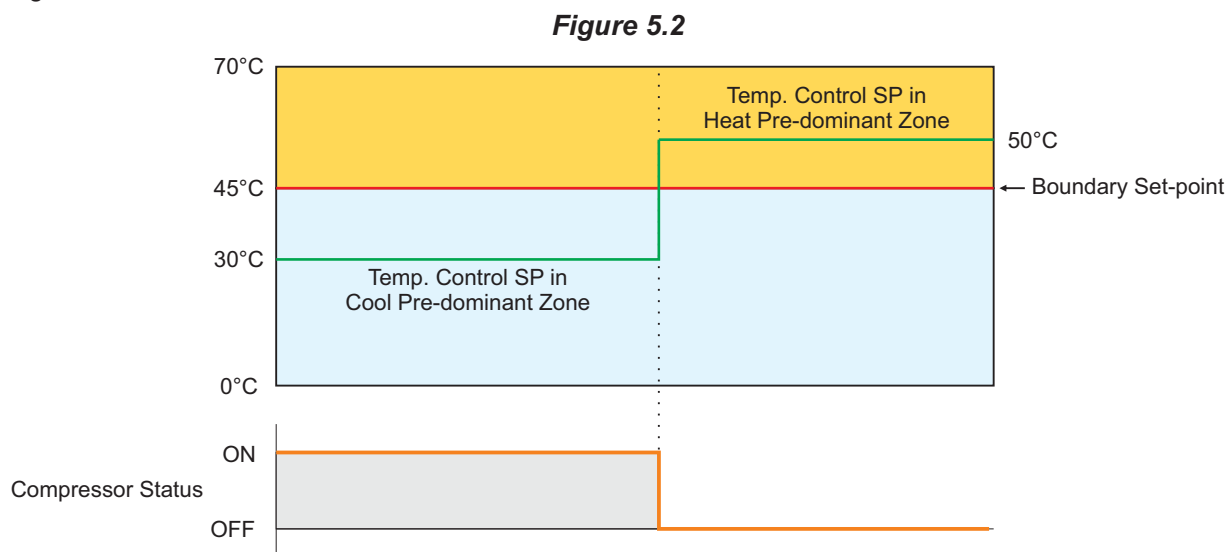

The zone at and above the boundary SP () is referred as Heat Pre-dominant zone and that below the boundary SP () is referred as Cool Pre-dominant zone. The controller automatically switches between the two zones depending upon the Temperature SP. If the Temperature SP is below boundary SP, Cool Pre-dominant zone is active and the compressor is kept ON. If the Temperature SP is at or above boundary SP, Heat Pre-dominant zone is active and the compressor is kept OFF. This strategy eliminates the need for the user to manually switch the compressor ON or OFF.

If the parameter *Control Zones* is set to “Dual”; separate tuning can be performed in the Cool and Heat Pre-dominant zones for accurate control in each zone. The controller maintains separate sets of Proportional Band, Integral Time & Derivative Time constants for each zone that are automatically selected and used by the controller depending upon the active zone.

However, if the parameter *Control Zones* is set to “Single”; the controller uses a single set of Proportional Band, Integral Time & Derivative Time constants for both zones.

4. PV Based Strategy

In this strategy, the compressor is switched to cool down the air temperature. The controller switches the compressor ON or OFF based on the comparison between the Measured & Set Temperature values. Refer Figure 5.3 below.

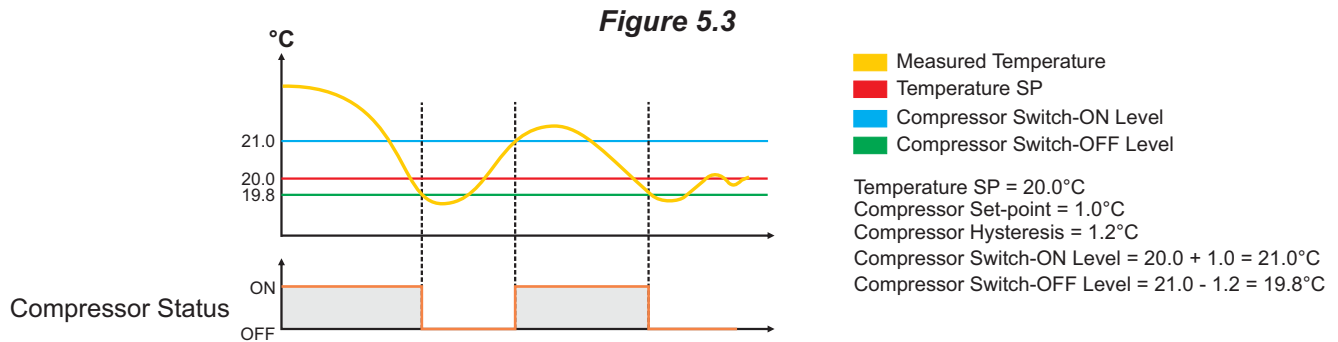

The compressor is turned ON if the chamber air temperature value is above the Temperature SP by an amount set by the parameter 'Compressor Set-point'. That is;

$$\text{Compressor Switch - ON Level} = (\text{Temperature SP}) + (\text{Compressor Set-point})$$

Once the air temperature falls below Compressor Switch-ON Level by an amount set by the parameter 'Compressor Hysteresis', the compressor is turned OFF. That is;

$$\text{Compressor Switch - OFF Level} = (\text{Compressor Switch-ON Level}) - (\text{Compressor Hysteresis})$$

The hysteresis inserts a dead band between the Compressor Switch-ON Level and Compressor Switch-OFF Level to avoid frequent switching of the compressor.

Compressor Time Delay

Once the compressor is switched off, a time delay is desired before it is turned ON again. The time delay prevents the possible damage due to short cycling. When the compressor switches off, it spins backward as pressure equalizes. If compressor is energized while it is still spinning backward, it continues to run backward until it trips on internal overloads. This may cause damage to the compressor.

The time delay cycle is executed every time the compressor is turned off. The compressor turning off may be a result of power failure or the on-off control algorithm executed by the controller. The controller in "Auto Mode" monitors the Process Value (PV) against the Set-Point (SP) and attempts to switch the compressor ON or OFF depending upon whether the PV is *above* or *below* the SP.

The time delay starts counting down from the instance the compressor is switched off. The compressor is inhibited from switching-on until the delay elapses regardless of the difference between the PV and SP. Once the time delay is elapsed, the control algorithm switches the compressor ON as and when the PV is above SP.

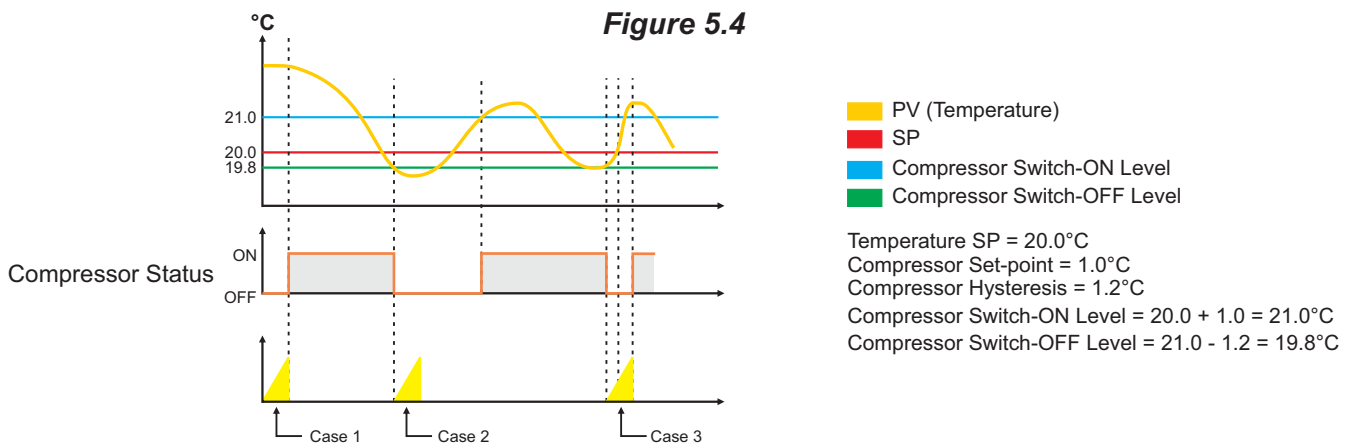

The figure 5.4 above illustrates 3 cases. Case (1) illustrates power-up delay. In case (2); the time elapses before PV rises above the SP. The compressor is thus switched ON as soon as the PV rises above the SP. In case (3); the PV rises above the SP while the time delay is still in progress. The compressor is switched ON as soon as the delay time elapses.

Table 5.3 lists various parameters required for setting-up appropriate compressor switching strategy and associated parameters.

For parameter description the user is requested to read the preceding section.

Table 5.3

Parameter Description	Settings (Default Value)
<p>CONTROL STRATEGY >></p> <p><i>Heat Only</i> Used in applications like Heating Oven, Vacuum Oven, Muffle Furnace, etc.; that require raising the temperature above ambient. The HTR (Heater) control output switches 'heating source' for maintaining the temperature at desired setpoint. The CMP (Compressor) control output is inactive (kept off).</p> <p><i>Cool Only</i> Used in applications like Deep Freezer, Cold Cabinet, Lab Refrigerator, etc.; that require lowering the temperature below ambient. The CMP (Compressor) control output switches 'cooling source' for maintaining the temperature at desired setpoint. The HTR (Heater) control output is inactive (kept off).</p> <p><i>Heat + Cool</i> Used in applications like Environment Chamber, BOD Incubator, etc.; that require either lowering the temperature below or raising the temperature above ambient. Both, the CMP (Compressor) and HTR (Heater) control outputs switch 'cooling source' & 'heating source', respectively, for maintaining the temperature at desired setpoint.</p>	<p>Heat Only Cool Only Heat + Cool (Default : Heat + Cool)</p>

Parameter Description		Settings (Default Value)
Control Strategy : Cool Only		
TIME DELAY (SEC) >>		0 to 1000 Sec (Default : 200 Sec)
Control Strategy : Heat + Cool		
COMPRESSOR STRATEGY >>		CONT. OFF CONT. ON SP BASED PV BASED (Default : CONT. ON)
CONT. ON	SP BASED	PV BASED
TIME DELAY (SEC) >> 0 to 1000 Sec (Default : 200 Sec)	BOUNDARY SET VALUE >> 0 to 100 <i>(Resolution 0.1°C for RTD / DC Linear & 1°C for Thermocouple)</i> (Default : 45.0)	TIME DELAY (SEC) >> 0 to 1000 Sec (Default : 200 Sec)
	CONTROL ZONES >> SINGLE DUAL (Default : SINGLE)	
	TIME DELAY (SEC) >> 0 to 1000 Sec (Default : 200 Sec)	

FACTORY > SOAK TIMER PARAMETERS

Parameter Description	Settings (Default Value)
ENABLE >> Yes Soak Timer function and Start / Abort commands are enabled. No Soak Timer function and Start / Abort commands are disabled.	No Yes (Default : No)
START BAND >> After issuance of start command, the timer starts counting down once the PV enters the process band around SP defined by this parameter value.	0 to 999.9 (Default : 0.5)

FACTORY > SOAK TIMER PARAMETERS

Parameter Description	Settings (Default Value)
<p>HOLDBACK STRATEGY >> <i>None</i> PV based timer pause is not required.</p> <p><i>Up</i> Timer is paused if PV is outside holdband <i>above</i> SP.</p> <p><i>Down</i> Timer is paused if PV is outside holdband <i>below</i> SP.</p> <p><i>Both</i> Timer is paused if PV is outside holdband either <i>above</i> or <i>below</i> SP.</p>	<p>None Up Down Both (Default : None)</p>
<p>HOLD BAND >> Sets the temperature limit(s) with respect to the SP for the timer to pause. The timer holds on counting should the PV cross the limit(s).</p>	<p>0.1 to 999.9 (Default : 0.5)</p>
<p>HEAT OFF >> Heater is turned off, once Soak Timer operation is over.</p>	<p>No Yes (Default : No)</p>
<p>COOL OFF >> Compressor is turned off, once Soak Timer operation is over.</p>	<p>No Yes (Default : No)</p>
<p>POWER RECOVERY >> <i>Abort</i> The timer operation is suspended until a new start command is issued.</p> <p><i>Re-Start</i> The timer re-runs the complete soak time.</p> <p><i>Continue</i> The Soak Timer resumes operation for the balance time.</p>	<p>Abort Restart Continuous (Default : Restart)</p>

FACTORY > DOOR OPEN

Parameter Description	Settings (Default Value)
<p>ENABLE >></p> <p>Set to 'Yes' if Switch is mounted for detecting door <i>Open / Close</i> position.</p>	<p>YES NO (Default : NO)</p>
<p>SWITCH LOGIC >></p> <p><i>Close : Door Open</i> The Door position is considered <i>Open</i> if the switch is CLOSE.</p> <p><i>Open : Door Open</i> The Door position is considered <i>Open</i> if the switch is OPEN.</p>	<p>CLOSE : DOOR OPEN OPEN : DOOR OPEN (Default : CLOSE : DOOR OPEN)</p>
<p>DOOR ALRM DLY (SEC) >></p> <p>This parameter sets a timer. From the time the door is opened, the timer begins counting down. If the door is not closed before the timer reaches 0, the <i>Door Open</i> alarm is activated.</p>	<p>0 to 1000 Sec (Default : 60 Sec)</p>

FACTORY > MAINS FAILURE

Parameter Description	Settings (Default Value)
<p>ENABLE >></p> <p>Set to 'Yes' if provision is made for running the controller on an auxiliary power sources like battery or inverter and a Switch is mounted for detecting main power source failure.</p>	<p>YES NO (Default : NO)</p>
<p>SWITCH LOGIC >></p> <p><i>Close : Mains Fail</i> The CLOSE Switch position indicates that the Mains Power has failed and the Controller is operating on auxiliary power source.</p> <p><i>Open : Mains Fail</i> The OPEN Switch position indicates that the Mains Power has failed and the Controller is operating on auxiliary power source.</p>	<p>CLOSE : MAINS FAIL OPEN : MAINS FAIL (Default : CLOSE : MAINS FAIL)</p>

FACTORY > SMS ALERT

The 'SMS ALERT' group is available only if the controller is supplied with GSM Module Version.

Parameter Description	Settings (Default Value)
ENABLE >> Set this parameter to 'No' if GSM module is not attached or SMS alerts are not required.	YES NO (Default : NO)
RESET GSM MODULE >> Use this parameter (Set to 'Yes') if for any reason the GSM module fails to send SMS alerts.	YES NO (Default : NO)
MAP SMS ENABLE >> If this parameter set to 'No' the controller will not send SMS alerts if any of the Mapping Channels is under alarm.	YES NO (Default : NO)

FACTORY > FACTORY DEFAULT

Parameter Description	Settings (Default Value)
SET TO DEFAULT >> Set to 'Yes' to set all the parameter values to their Default Values.	YES NO (Default : NO)

FACTORY > PASSWORD

Parameter Description	Settings (Default Value)
CHANGE PASSWORD >> The Controller is shipped from the factory with a default password (321) for accessing the parameters reserved for the equipment manufacturer. However, if required the password can be changed by setting the new value for this parameter. (The new password replaces the old password. That is, the old password is no longer valid. it is user's responsibility to memorize the password.)	2000 to 2999 (Default : 321)

FACTORY > EXIT

Parameter Description	Settings (Default Value)
EXIT SETUP MODE >> Select 'Yes' to quit <i>Setup</i> mode and return to <i>Main Display</i> mode.	YES NO (Default : NO)

Section 6

PANEL MOUNTING AND ELECTRICAL CONNECTIONS

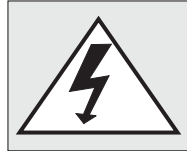

WARNING
MISHANDLING / NEGLIGENCE
CAN RESULT IN PERSONAL DEATH
OR SERIOUS INJURY.

PANEL CUTOUT

Figure 6.1

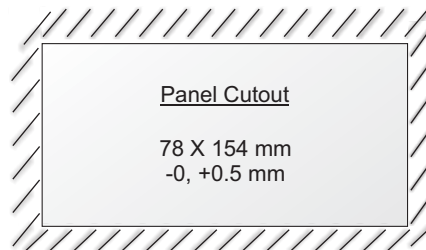

PANEL MOUNTING

Follow the steps below for mounting the instrument on panel :

1. Prepare a cutout to the size shown in Figure 6.1.
2. Remove the Panel Mounting Clamp from the instrument Enclosure.
3. Insert the rear of the enclosure through the panel cutout from the front of the mounting panel.
4. Fix the mounting clamp pair such that it ensures secured mounting of the enclosure against the panel wall.

ELECTRICAL CONNECTIONS

1. The user must rigidly observe the Local Electrical Regulations.
2. Do not make any connections to the unused terminals for making a tie-point for other wires (or for any other reasons) as they may have some internal connections. Failing to observe this may result in permanent damage to the controller.
3. Run power supply cables separated from the low-level signal cables (like **RTD**, **DC** Linear Current/Voltage, etc.). If the cables are run through conduits, use separate conduits for power supply cable and low-level signal cables.
4. Use appropriate fuses and switches, wherever necessary, for driving the high voltage loads to protect the controller from any possible damage due to high voltage surges of extended duration or short-circuits on loads.
5. Take care not to over-tighten the terminal screws while making connections.
6. Make sure that the controller supply is switched-off while making/removing any connections or removing the controller from its enclosure.

CONNECTION DIAGRAM

The Electrical Connection Diagram is shown on the back side of the controller enclosure. The diagram shows the terminals viewed from the **REAR SIDE** with the controller label upright. Refer figure 6.2 for version with 4 Mapping Channels.

Figure 6.2(b) : 4 Mapping Channels

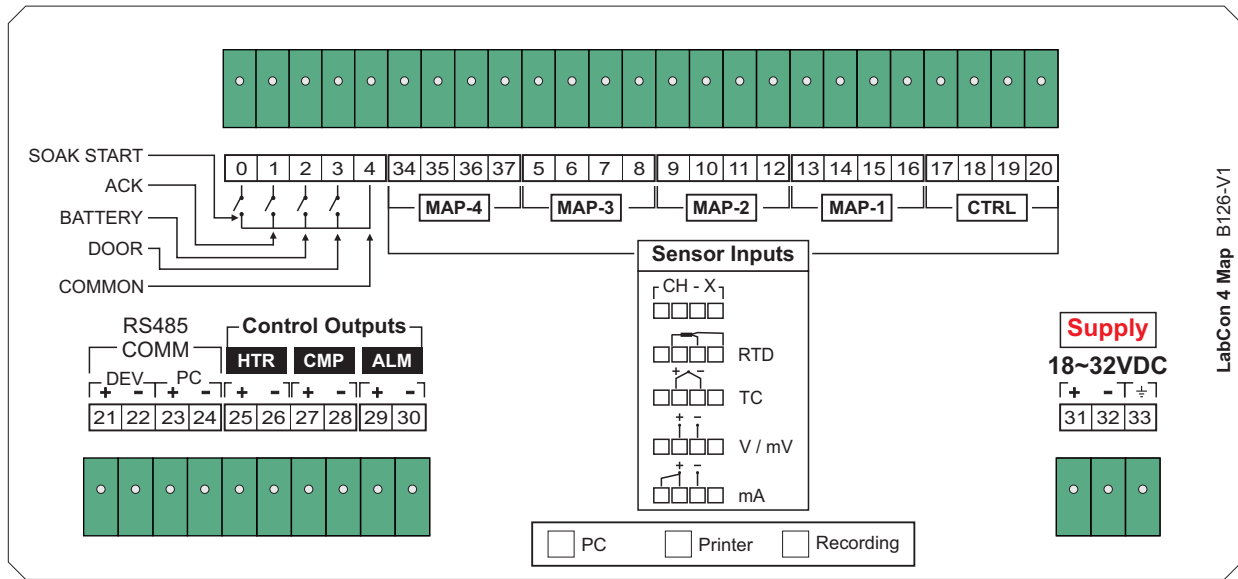

DESCRIPTIONS

The back panel connections are described as under:

Temperature Sensor / Transmitter Inputs for Control & Mapping

The Input for control channel is settable as RTD Pt100 (3-wire / 2-wire), Thermocouple or DC Current (mA) / DC Voltage (V) independent of the input type for Mapping channels.

The Mapping channels must have the same input type (independent of Control channel) settable as RTD Pt100 (3-wire / 2-wire) or DC Current (mA) / DC Voltage (V).

The connections are described.

Figure 6.3

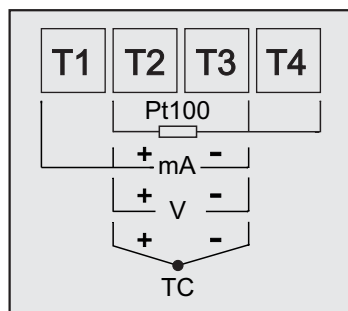

	CTRL Terminals	MAP-1 Terminals	MAP-2 Terminals	MAP-3 Terminals	MAP-4 Terminals
T1	17	13	9	5	34
T2	18	14	10	6	35
T3	19	15	11	7	36
T4	20	16	12	8	37

Figure 6.4 (a)

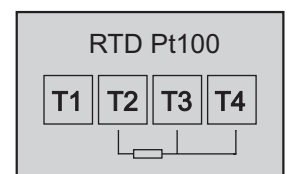

RTD Pt100, 3-wire

Connect single lead end of RTD bulb to terminal T2 and the double lead ends to terminals T3 & T4 as shown in Figure 6.4(a). Use copper conductor leads of very low resistance ensuring that all 3 leads are of the same gauge and length. Avoid joints in the cable.

Temperature Transmitter with DC Voltage (V) Output

The Figures 6.4(b) depicts wiring connections for voltage output transmitter. An external Excitation Voltage source should be used for powering the transmitter.

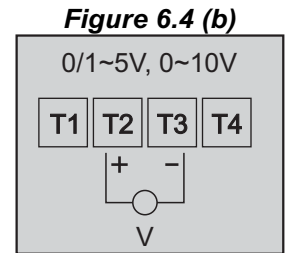

Temperature Transmitter with DC Current (mA) Output

The Figures 6.4(c) depict wiring connections for current output transmitter. Note that terminals T1 & T2 should be shorted. An external Excitation Voltage source should be used for powering the transmitter.

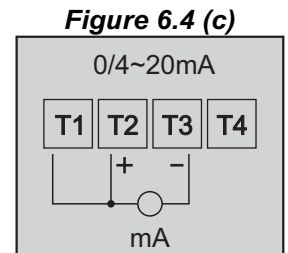

Thermocouple

Connect Thermocouple Positive (+) to terminal T2 and Negative (-) to terminal T3 as shown in Figure 6.4 (d). Use correct type of extension lead wires or compensating cable. Avoid joints in the cable.

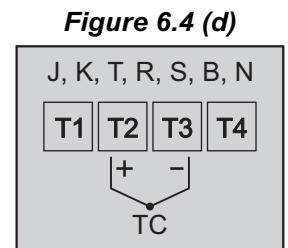

Heater Control Output (Terminals : 25, 26)

Compressor Control Output (Terminals : 27, 28)

Alarm Output (Terminals : 29, 30)

All the above control & alarm outputs are Voltage pulses (12VDC @ 40mA) for driving external SSR or Relay. The '+' and '-' terminals are for voltage 'Source' and 'Return' paths, respectively.

Door Detect Digital Input (Terminals 3, 4)

Battery Detect Digital Input (Terminals 2, 4)

Alarm Acknowledge Digital Input (Terminals 1, 4)

Soak Start Digital Input (Terminals 0, 4)

Potential-free contact closure input terminals are provided as digital inputs. An 'Open' or 'Close' switch position is detected as input.

PC COMMUNICATION PORT (Terminals 23, 24)

Figure 6.5

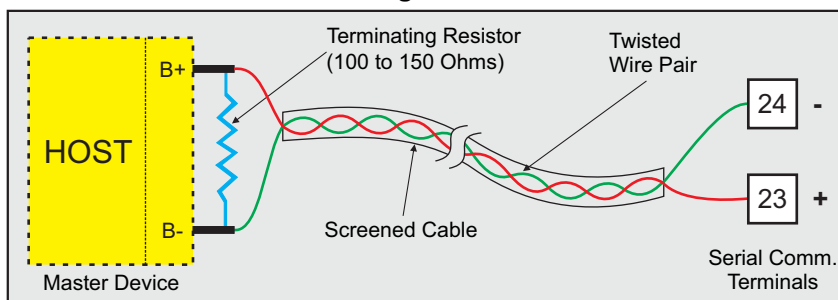

The controller Communication Port is RS485 and requires a similar port at the host (master) end. If, however, the host port is different (say, RS232), use appropriate protocol converter (say, RS485-RS232) for interface.

For reliable noise free communication, use a pair of twisted wires inside screened cable as shown in Figure 6.5. The wire should have less than 100 ohms / km nominal DC resistance (Typically 24 AWG or thicker). Connect the terminating resistor (Typically 100 to 150 ohm) at one end to improve noise immunity.

PRINTER / GSM INTERFACE COMMUNICATION PORT (Terminals 21, 22)

If the controller supports Dot Matrix Printer or GSM module interface, use RS485 Communication Port available on terminals 21 & 22.

POWER SUPPLY (Terminals 31, 32 & 33)

Figure 6.6

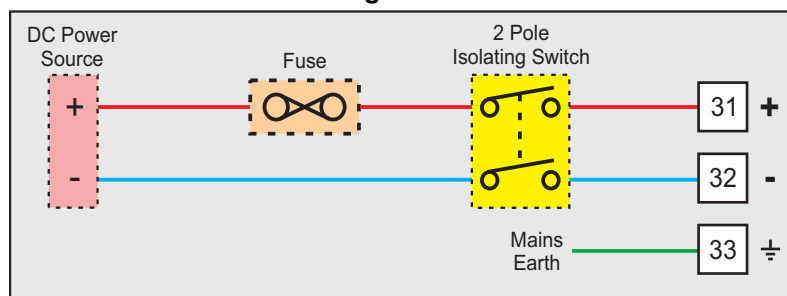

As standard, the Module is supplied with power connections suited for 18 to 32 VDC power source. The accuracy / performance of the Module is not affected by the variations in the supply within specified limits of 18 to 32 VDC. Use well-insulated copper conductor wire of the size not smaller than 0.5mm² for power supply connections ensuring proper polarity as shown in Figure 6.6. The Module is not provided with fuse and power switch. If necessary, mount them separately. Use a slow blow fuse rated for 0.5A current.

For safety and enhanced electrical noise immunity, it is highly recommended to connect Main Power Supply 'Earth' to terminal 33.



APPENDIX - A

DC LINEAR SIGNAL INTERFACE

This appendix describes the parameters required to interface process transmitters that produce Linear DC Voltage (mV/V) or Current (mA) signals in proportion to the measured process values. A few examples of such transmitters are;

1. Pressure Transmitter producing **4 to 20 mA** for **0 to 5 psi**
2. Relative Humidity Transmitter producing **1 to 4.5 V** for **5 to 95 %RH**
3. Temperature Transmitter producing **0 to 20 mA** for **-50 to 250 °C**

The instrument (indicator/controller/recorder) that accepts the linear signal from the transmitter computes the measured process value by solving the mathematical equation for Straight-Line in the form:

$$Y = mX + C$$

Where;

- X : Signal Value from Transmitter
- Y : Process Value Corresponding to Signal Value X
- C : Process Value Corresponding to X = 0 (Y-intercept)
- m : Change in Process Value per unit Change in Signal Value (Slope)

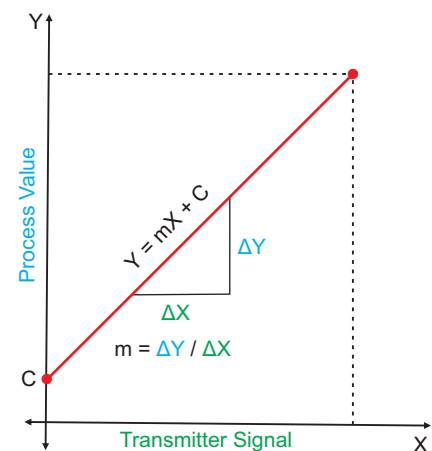

As is evident from the aforementioned transmitter examples, different transmitters produce signals varying both in *Type* (mV/V/mA) and *Range*. Most PPI instruments, thus, provide programmable Signal Type and Range to facilitate interface with a variety of transmitters. A few industry standard signal types and ranges offered by the PPI instruments are: 0-50mV, 0-200mV, 0-5 V, 1-5 V, 0-10V, 0-20 mA, 4-20 mA, etc.

Also, the output signal range (e.g. 1 to 4.5 V) from different transmitters corresponds to different process value range (e.g. 5 to 95 %RH); the instruments thus also provide facility for programming the measured process value range with programmable Resolution.

The linear transmitters usually specify two signal values (Signal Low and Signal High) and the corresponding Process Values (Range Low and Range High). In the example Pressure Transmitter above; the Signal Low, Signal High, Range Low & Range High values specified are: 4 mA, 20 mA, 0 psi & 5 psi, respectively.

In summary, the following 6 parameters are required for interfacing Linear Transmitters:

1. Input Type : Standard DC Signal Type in which the transmitter signal range fits (e.g. 4-20 mA)
2. Signal Low : Signal value corresponding to Range Low process value (e.g. 4 mA)
3. Signal High : Signal value corresponding to Range High process value (e.g. 20 mA)
4. PV Resolution : Resolution (least count) with which to compute process value (e.g. 0.01)
5. Range Low : Process value corresponding to Signal Low value (e.g. 0.00 psi)
6. Range High : Process value corresponding to Signal High value (e.g. 5.00 psi)

The following examples illustrate appropriate parameter value selections.

Example 1: Pressure Transmitter producing 4 to 20 mA for 0 to 5 psi

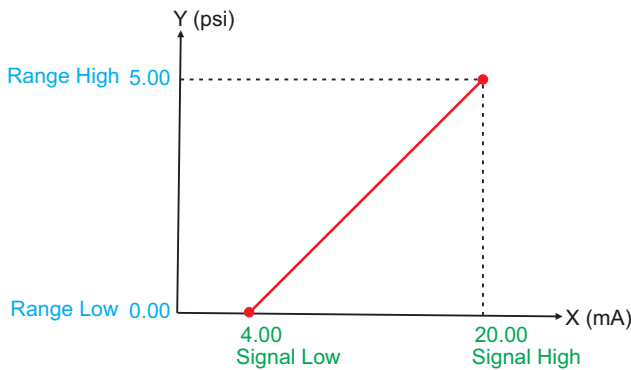

Presume the pressure is to be measured with 0.01 Resolution, that is 0.00 to 5.00 psi.

Input Type : 4-20 mA
 Signal Low : 4.00 mA
 Signal High : 20.00 mA
 PV Resolution : 0.01
 Range Low : 0.00
 Range High : 5.00

Example 2: Relative Humidity Transmitter producing 1 to 4.5 V for 5 to 95%RH

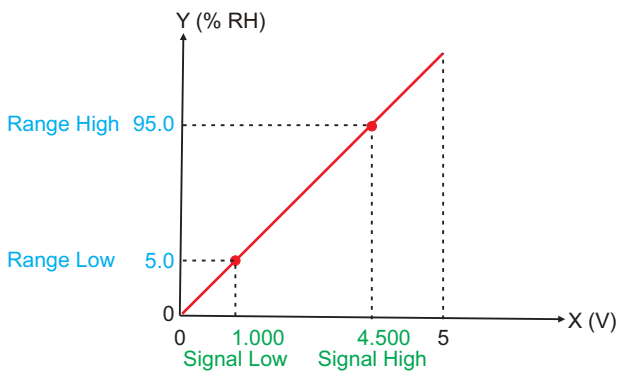

Presume the humidity is to be measured with 0.1 Resolution, that is 0.0 to 100.0 %.

Input Type : 0-5 V
 Signal Low : 1.000 V
 Signal High : 4.500 V
 PV Resolution : 0.1
 Range Low : 5.0
 Range High : 95.0

Example 3: Temperature Transmitter producing 0 to 20 mA for -50 to 250 °C

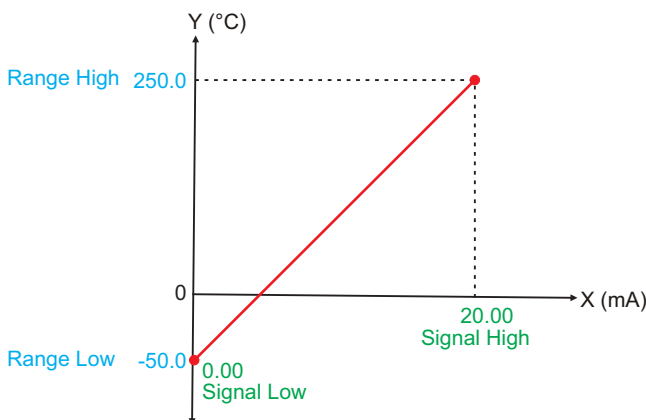

Presume the Temperature is to be measured with 0.1 Resolution, that is -50.0 to 250.0°C.

Input Type : 0-20 mA
 Signal Low : 0.00 mA
 Signal High : 20.00 mA
 PV Resolution : 0.1
 Range Low : -50.0
 Range High : 250.0





PPI
The Perfection Experts

Process Precision Instruments

101, Diamond Industrial Estate, Navghar, Vasai Road (E),
Dist. Palghar - 401 210. Maharashtra, India



Sales : 8208199048 / 8208141446

Support : 07498799226 / 08767395333



sales@ppiindia.net, support@ppiindia.net